



**WASHING  
AS IT  
SHOULD BE**

 **AGGREGATES**  **RECYCLING**  **INDUSTRIAL SANDS**  **MINING**  **WATER MANAGEMENT**

 **PRODUCT RANGE**



AggreSand™ 206 & AggreScrub™ 150, Broom, UK

## CONTENTS

Washing As It Should Be..... 5  
 Washing Made Simple .....6-7

### APPLICATION SOLUTIONS

Aggregates.....8-9  
 Recycling.....10-11  
 Industrial Sands.....12-13  
 Mining.....14-15  
 Water Management.....16-17  
 4SITE.....18  
 Applications, Training & Support, Laboratory Testing.....19

### YOUR PRODUCT CHOICE

#### MODULAR SOLUTIONS

Aggresand™ .....21-23  
 Aggwash™ .....24-25  
 AggreScalp™ .....26-27

#### SCRUBBING

AggreScrub™ .....28-29

#### SCREENING

M Range .....30  
 Sreenbox Range .....31

### WASHING & CLASSIFYING

FM Compact.....32  
 FM Hydro.....33  
 FM UltraFines.....34-35  
 FM Direct Feed.....36  
 FM Conexus.....37  
 FM Bucket Wheel.....38  
 Bucket Wheel Sand Plants.....39  
 Mobile Sand Screw Plants.....40  
 Sand Screw Plants.....41  
 Frac Pro & Attrition Cells.....42

### FEEDERS

H Range.....43

### STACKING

AggreStac™.....44  
 Modular Conveyors.....45-46

### WATER MANAGEMENT SOLUTIONS

Waterpumps.....47  
 Water Management Solutions.....48-49

### TWS SERVICES FOR YOU

Growing Global Network.....50  
 Distributor Network.....51  
 Automation & Control.....52  
 Finance.....53



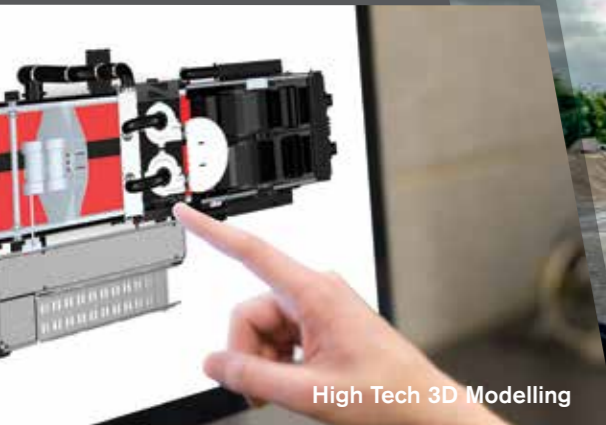

High Tech 3D Modelling

An unrivalled heritage of over 60 years development experience and expertise in the washing solutions industry, has resulted in today's world class leading equipment - turning virgin and waste materials and minerals into high value, saleable products.

AggreSand™ 165, Ireland

## WASHING AS IT SHOULD BE

Terex® Washing Systems (TWS) is the premier provider of advanced plant solutions for material and mineral washing needs in aggregates, recycling, industrial sands and mining.

An unrivalled heritage of over 60 years development experience and expertise in the washing solutions industry, has resulted in today's class leading equipment - turning virgin or waste materials and minerals into high value, saleable products.

As stringent materials regulations and the need for clean aggregates increases internationally, TWS has become a world leader in providing high quality, high efficiency and rapid return on investment solutions.

Our design and manufacture is driven by a spirit of innovation, universal health and safety and response to market demands, resulting in unique, market leading products and world class machines designed for world beating performance.

A complete range of in-house project specialisations ensures that from customer brief to tailor-made solution, every aspect of every commission is unique and every aspect of client service is covered.

TWS is headquartered in Northern Ireland with additional centres of excellence in Europe, Asia, Australia and America. We also partner with qualified and respected organisations worldwide to bring our customers consistent lifetime service, local expertise and knowledge and local aftersales. Our modular machines and parts are held in stock regionally and with our distributors guaranteeing fast response to our end users.

A unique level of focus and specialisation and an unparalleled washing heritage have made TWS the supply partner of choice for a wide range of operators, from independently owned one-site quarries through to international mining and construction organisations.



AggreSand™ 206 Control Panel

# WASHING MADE SIMPLE

With a history spanning decades TWS have amassed unrivalled project experience and the product portfolio to match. Recognising the unique characteristics of the different industry sectors that we serve TWS have evolved 5 key segments; **Aggregates, Recycling, Mining, Industrial Sands, and Water Management**. Each sector brings a unique set of challenges and customer expectations and TWS tailor equipment and services offerings to match. Whilst operators across these segments have highly diverse input materials and production goals, all are consistent in their need for readily installed, highly efficient, rapid return on investment equipment solutions. These are the core driving principles of TWS design. Whether you need a compact station to recover maximum solids from a dredged slurry; you need to consistently achieve concrete specification sand with a variable feed source; or you need to maximise the Fe value of iron ores fines, TWS have the equipment and the experience to help.

New products and solutions are continuously developed to keep TWS at the cutting edge of the materials washing market and we constantly explore new materials, new sectors and new challenges. TWS are leading the sector's development towards compact modular systems bringing customised solutions to customers who were previously limited to capital intensive and highly inflexible conventional solutions.

---

Each sector brings a unique set of challenges and customer expectations and TWS tailor equipment and service offerings to match.

---

- AGGREGATES**
- RECYCLING**
- INDUSTRIAL SANDS**
- MINING**
- WATER MANAGEMENT**

## MODULAR SOLUTIONS



Today's end users rightly expect total understanding of their requirements and total performance. TWS was founded on this principle and we have combined our ability to offer competitive single unit 'standardised' equipment with the capacity to design and deliver complete turnkey projects for even the most demanding materials and requirements.

## SCRUB



Static and modular systems offering aggressive attrition for sticky and high clay content materials. Highly effective with overburdens, clay-bound ores and recycled materials containing lightweight contaminants.

## SCREEN



From our unique track mounted M-Series which can operate on a wet or dry basis through to our comprehensive range of static and modular units for sizing and dewatering TWS offers a substantial selection of screens covering numerous applications and sectors.

## WASH & CLARIFY



Highly comprehensive range of dewatering options for fine materials including screw dewaterers, bucket wheels, and hydrocyclone technologies, all proven on a global basis. Unique ability to offer off-the-shelf ready-made products or to design complete bespoke solutions.

## FEED & STACK



High performance, heavy duty electrical screening solutions, ideal for aggregate and recycling applications or you can opt for our stand alone feeder options. Cost effective efficient modular and mobile units that can be used on a stand-alone basis or integrated with larger TWS systems. Hydraulic, electric, static, mobile. Move it, wash it, stack it, sell it.

## WATER MANAGEMENT



All washing systems need water but TWS designs and efficiencies keep requirements to a minimum. Proven water management and recycling systems, from thickeners to filter presses and moisture reclamation systems, ensure that operators in even the most controlled or arid environments can produce high quality materials at a low cost per ton.

## AGGREGATES

From sand used in Dubai's most audacious construction projects to aggregates supplied to the London Olympic preparations TWS are relied upon by World leading contractors and building materials suppliers to provide the highest quality in-spec. products.

Bringing more than 60 years of washing sector experience spanning the widest range of raw material types, final product requirements and geographical variations TWS provides the complete portfolio of products and services to suit your application. Whilst materials and output requirements vary with each project all aggregate sector clients have the same core needs: high quality, low cost per ton materials. TWS provides versatile modular systems, designed to be installed as quickly as possible and as easily as possible. In an ever changing market place they are ready to move when you are, and with a broader network of qualified dealers than any other washing equipment supplier we are dedicated to being close to you at each step of your project.

TWS products offer the performance, reliability and longevity to deliver. From the T150 bucket wheel dewaterer, one of the most widely distributed sand washing machines in the World to the sector defining AggreSand – the World's first chassis mounted integrated system offering 5 washed products TWS is always innovating, always one step ahead.

Whether you operate a natural sand and gravel pit, need to recover commercial grade aggregates from overburden, dredged recovery or crushed rock fines TWS are ready to deliver on promises that will let you keep yours.

---

Always innovating,  
always one step ahead.

---

High Frequency Dewatering Screen



### DID YOU KNOW?

That aggregates used in the construction of the Britain - France Channel Tunnel was washed using a Terex Washplant.



Part Rinsing/Sizing Screen

## RECYCLING

As an Island nation with high population density and high construction activity the UK has become a national case study in construction materials recycling. Terex Washing have been at the vanguard of UK recycling process developments, leading the move from a crush and screen approach to a more holistic value addition format. With the ability to draw upon unmatched crushing, screening, washing and water management product range, Terex offers the most complete and proven end to end solutions in wash recycling.

We understand the specific challenges raised by recycled materials: high variability of materials, need for high quality production, limited water availability, constraints on planning parameters and land availability, preferences for systems which can be easily relocated if required. Our AggWash and AggreScrub systems demonstrate our recognition of these issues and our ability to bring solutions, having been primarily designed for the construction and demolition recycling sector. Of course they have since proved their value in a wide range of applications.

Construction and demolition waste recycling is now one of the most eagerly discussed sectors within the construction materials industry at an international level and TWS is uniquely ready to meet this challenge. Our constantly evolving product and process solutions ensure maximum productivity and most importantly product quality. From a commercial perspective the operator can expect higher output, higher revenue products, lower waste generation and low production costs.



**See our Recycling brochure for our complete solution offering**

Our constantly evolving product and process solutions ensure maximum productivity and most importantly product quality.



AggreScrub™ 150, UK



### DID YOU KNOW?

Recycled aggregates used in the construction of facilities used for the Commonwealth Games 2014 were washed using a Terex Washplant.

## INDUSTRIAL SANDS

One of the most specialised and diverse sectors within materials processing is the rapidly evolving world of industrial sands, particularly silica sand. High quality silica sand has become a much sought after commodity and whilst the range of clients is almost as diverse as the range of end uses for their sands we find they have a number of notable core requirements in common. Maximum SiO<sub>2</sub> content, reduced clay fractions, reduced metallic contamination and of course efficient and highly accurate size separation.

Our systems have long been used within the industrial sand sector but we are committed to understanding current and future market needs and offering equipment today which will solve tomorrows' problems. The system is also highly flexible to accommodate industrial sand applications beyond the fracking sector; for example sports sand product, filter sand, glass sand and foundry sands.

From a single unit scope of supply through to a complete project solution TWS are ready to and value to your materials and to your operations.



**See our Industrial Sands brochure for our complete solution offering**



FM Hydro sand classification plant combining sand washing and sizing on one unit

---

**We are committed to understanding current and future market needs and offering equipment today which will solve tomorrow's problems.**

---



### DID YOU KNOW?

Sand used in the construction of the Burj-Al-Arab Hotel, Dubai was washed using a T100.



## MINING

It's no secret that the global mining sector has had many new challenges to face in recent years with fluctuating commodity prices and ever increasing social and environmental scrutiny. TWS is dedicated to delivering innovative systems which increase mine yields, efficiencies and flexibility and reducing potential environmental impact. We have specifically adapted systems to accommodate a range of materials. Examples of our broad experience includes iron ore applications in India, coal processing in Australia and diamond recovery in Africa.

The environmental benefits delivered through increased efficiency are clear but so too are the return on investment opportunities for operators looking for alternatives to conventional large scale static plant. Rapid mobilisation and scalable modular systems are the key, coupled with maximum recovery of commercially viable materials thereby reducing waste and by products and ensuring that water is properly managed.

When the iron ore sector in India was striving to find ways to handle lower grade feed stocks, particularly accumulated low Fe fines Terex was at the forefront adapting and developing systems and investing in World class production facility in Hosur. This underlines our commitment to providing more than mechanical solutions. As a Global company we are there in your market, ready to work with you to find better, more efficient, and lower impact ways of delivering the materials needed by industry.

---

**As a Global company we are there in your market, ready to work with you to find better, more efficient, and lower impact ways of delivering the materials needed by industry.**

---



### DID YOU KNOW?

Sand used in the construction of the Istanbul 'Third Bridge' was washed using a FM120BW.





### DID YOU KNOW?

Material used in the construction of the Brenner Base Tunnel (Austria) is being washed using an AggreSand™ 165.



Whichever material you wash you will need water. With TWS you need less. We start by designing our equipment to ensure that unnecessary losses through spillage and leaks is eliminated. Then we optimise processes to ensure that water is internally recycled and reused wherever possible. A good example would be the ground sumps that we often use to capture and reuse rain plant wash down and rain water.

Our Applications & Engineering Review team produce a detailed mass balance flow drawing for every project and here we can clearly identify all channels for water loss and again consider case by case possibilities for reduction. The main losses for any system will be in washed product stockpiles and with the final undersize fraction.

Our advanced dewatering systems ensure that stockpiles are as dry as possible, presenting ready to use or sell material with minimal water content. This can be further enhanced through the use of our stockpile dewatering systems, drawing water back from the stockpiles to the washing circuit.

We offer a range of solutions to manage the process water depending on the material type, volumes, settlement characteristics, space, budget and mobility limitations. A complete approach will typically include thickener (either deep cone or rake format) followed by a filter press, carefully sized on a case by case basis to provide consistently dewatered tailings, maximum water return to the system and of course low operation and maintenance costs.



---

Whichever material you wash you will need water.

With Terex Washing Systems you need less.

---

With you every step of the way.

# 4SITE

## A COMPLETE PROJECT MANAGEMENT SERVICE

Each of our project management packages include **4 Key Steps**.

TWS offer **4SITE**, a comprehensive project management service which provides you with enhanced levels of support during every step of your project. We believe that rapid-response, qualified, and effective support is crucial in meeting end-user needs, letting you deliver on your promise as well as developing long term client relationships.

Contact us today to discuss the best management package for your needs:  
[TWS.4Site@terex.com](mailto:TWS.4Site@terex.com)



- |  |   |  |  |
|--|---|--|--|
| <ul style="list-style-type: none"> <li>▪ Application Review</li> <li>▪ Sieve Analysis</li> <li>▪ Equipment selection and options confirmed through our Application and Engineering Review Process</li> <li>▪ Crossfunctional team review based on prior lessons learned</li> <li>▪ Initial Process Flow Diagram created and data reviewed</li> </ul> | <ul style="list-style-type: none"> <li>▪ Cross functional kick off meeting</li> <li>▪ Production control</li> <li>▪ Cost control</li> <li>▪ Risk management and mitigation</li> <li>▪ Tested equipment</li> <li>▪ Quality control from start to finish</li> <li>▪ Basic civils design</li> <li>▪ Electrical control</li> <li>▪ Shipping arrangements and machine packing</li> </ul> | <ul style="list-style-type: none"> <li>▪ Tailored installation plan specific to your project</li> <li>▪ Flexible levels of installation service team support</li> <li>▪ Schedule risk management and project log</li> <li>▪ Clear line of communication during installation and commissioning</li> <li>▪ Electrical support</li> </ul> | <ul style="list-style-type: none"> <li>▪ Aftersales and Engineering support via our Helpdesk</li> <li>▪ Ongoing Project support from time of order right through to commissioning</li> </ul> |
|--|---|--|--|



### APPLICATIONS

- Construction & Demolition Waste Material
- Virgin Aggregate
- Manufactured Sand
- Sand & Gravel
- Crushed Rock
- Crusher Dust
- Scalpings
- Iron Ore
- Other Mineral Ores



### TRAINING & SUPPORT

TWS offers fully tailored training packages for both dealers and customers alike. This training covers all aspects of our machinery, including basic operational data, correct sizing of screens, pumps, cyclones and full sales and application training.

**For further information on training or to book a training session email: [TWS.Applications@terex.com](mailto:TWS.Applications@terex.com)**



### LABORATORY TESTING

TWS offers full in-house sample analysis and testing of proposed products. This process allows us to specify the correct screening media apertures so that the customer achieves the desired product size. Sieve analysis is extensively used as a powerful quality control and acceptance tool. The gradation data is used to calculate relationships between various aggregates or aggregate blends, to predict trends during production and to check compliance with such blends.



We also test for many other factors including correct specification of flocculent type, oil / water separation etc.

**For further information on your requirements and to discuss your specific application: Email: [TWS.Applications@terex.com](mailto:TWS.Applications@terex.com)**



AggreSand™ 206, UK





## AggreSand™ 165 / 206

AggreSand™ is a highly versatile integrated washing station with outstanding performance capability across a wide range of materials and the ability to offer up to 5 washed and sized products. Its readily portable format makes it particularly suitable for green-field applications / contractor use / temporary planning permission sites but operators more used to static installations will still appreciate the small footprint and minimal site preparations required. In all cases installation time is significantly less than conventional builds thanks to the high level of factory pre-fitting and connections. The no-compromise design ethos adapted ensures maximum serviceability and performance despite the highly integrated and compact nature of the system with numerous innovative features including easily removed pumps, ready access to screening media and intuitive controls. The range includes numerous modular configurations but all are based around the choice of a 16x5' or 20x6' washing screen and a choice of sand output capacities.

### FEATURES AND BENEFITS

- Up to 3 washed aggregates & 2 washed sands
- Modular design with 'plug and play' electrical connections for quick set-up
- Pre-wired & pre-plumbed with single connection points
- Fully automated touch screen control providing all-round plant information
- Choice of grid and screen media options to suit your application
- Intelligent low level and easy access features for maintenance and wash down
- Transportable in 4-6 containers

### APPLICATIONS

-  AGGREGATES
-  RECYCLING
-  INDUSTRIAL SANDS
-  MINING



# AggreSand™ 165 / 206

## KEY FEATURES & BENEFITS

- Automated radial sand stockpilers
- 350m<sup>3</sup> (458yds<sup>3</sup>) stockpile per conveyor
- 800m<sup>3</sup> (1046yds<sup>3</sup>) single sand

- Choice of 3.m x1.5m (12'x5') DW screen (producing up to 120tph) or 4.8m x 1.8m (14' x 6') DW screen (producing up to 200tph)
- High frequency dewatering screen delivering superior moisture reduction

- Single or twin cyclones with drop in replaceable liners

- Choice of 4.9m x 1.5m (16'x5') or 6m x 1.8m (20'x 6') washing screen
- Isolated spraybars
- Polyurethane decks
- Sealed catchment tank rubber lined
- Aggregate blending chute
- Service accessible rolling chute

- Optional overband magnet for the removal of ferrous metals when operating in recycling applications

- Modular 12m<sup>3</sup> (16yds<sup>3</sup>) capacity hopper
- Radio controlled tipping grid or vibrating grid
- Variable speed belt feeder
- 37Kw (50hp) electric hydraulic powerpack

- Advanced automated control system with remote communication and radio

- All pumps have replaceable rubber liners for extended wear life
- Roll-out pump feature for easy maintenance

- 1050mm (41") wide belt
- Integrated sealed washbox
- Raisable head section for screen access





# AggWash™ AW60-1 / AW60-2 / AW 150 / AW 300

The AggWash™ is capable of producing up to four grades of aggregates and two grades of sand. The AggWash 60-2 was the world's first modular scrubbing station to integrate heavy attrition with sizing, lightweight contaminants removal and hydrocyclone based fines recovery in a single highly portable chassis. AggWash is a rapid-install solution for a wide range of applications within the aggregates, recycling, remediation and mining sectors.

Primarily designed for the processing of construction and demolition waste but equally suited to virgin material applications.

## APPLICATIONS

-  AGGREGATES
-  RECYCLING
-  MINING

## KEY FEATURES AND BENEFITS

- Screening, scrubbing, sizing and sand recovery on one modular chassis.
- Class leading walkaround access for maintenance
- Compact machine footprint
- Light-weight trash removal
- Quick set-up
- Pre-Piped & Pre-Wired



**WINNER 2010 WORLD DEMOLITION AWARDS**



- High Volume washbox
- Ensures effective fluidized feed material
- Rubber lined Roll out discharge chute
- Integrated oversize conveyor
- Twin shaft logwasher with angle adjustment
- Conglomerates broken up
- Organics & lights floated out
- Dual direct drives
- Enabling start up under load
- Class-leading all-around access for service and maintenance
- Rolling chutes to provide easy access for screen maintenance
- 4.9m x 1.5m (16' x 5') triple deck Terex® Cedarapids LJ-TS Series horizontal screen
- Three shaft vibrator mechanism
- Provides high G force along with the efficient oval motion
- 1.8m x 1.2m (6' x 4') trash screen
- Dewatering organics and lights
- Integrated 1 or 2 grade sand plant
- Rubber lined pumps and hydrocyclones
- Available in various configurations and capacities
- Robust modular chassis construction
- 4.9m x 1.5m (16' x 5') triple deck, part rinsing Terex® Cedarapids LJ-TS Series horizontal screen
- Producing up to 4 washed aggregates

# AggreScalp™

The Terex® AggreScalp™ is a versatile, high performance heavy duty electric screening machine that has the flexibility to operate as a 2-way or 3-way split screener. The highly aggressive screen can accept media including bofor bars, finger screens, woven mesh and 3D punch plates, which allows it to be used across a wide variety of applications.

With onboard hydraulic folding product conveyors, hydraulic screen angle adjustment and single lift set-up, it remains easy to transport and easy to set-up. The AggreScalp™ can work in conjunction with the Terex® AggreSand™ range by providing a consistent feed material even in difficult applications. Together they form an efficient, lower operating cost aggregate and recycling solution.

## FEATURES & BENEFITS

- Semi-mobile
- Electric powered (40Kw)
- Integrated hydraulic pack for set up
- Pre wired & pre plumbed
- Quick set up
- Integrated discharge conveyors
- 2-way & 3-way split

## APPLICATIONS



## KEY FEATURES AND BENEFITS

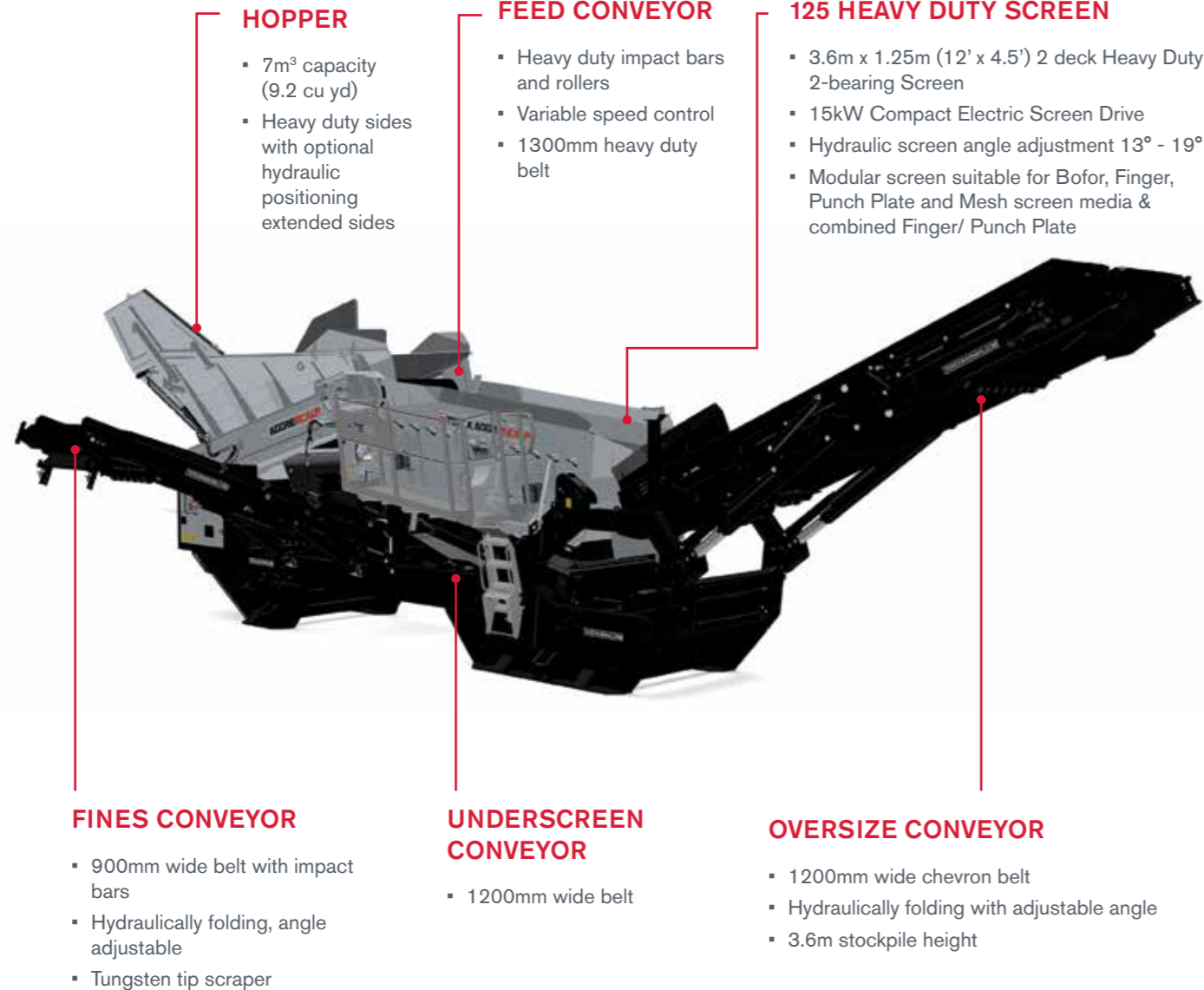

### HOPPER

- 7m³ capacity (9.2 cu yd)
- Heavy duty sides with optional hydraulic positioning extended sides

### FEED CONVEYOR

- Heavy duty impact bars and rollers
- Variable speed control
- 1300mm heavy duty belt

### 125 HEAVY DUTY SCREEN

- 3.6m x 1.25m (12' x 4.5') 2 deck Heavy Duty 2-bearing Screen
- 15kW Compact Electric Screen Drive
- Hydraulic screen angle adjustment 13° - 19°
- Modular screen suitable for Bofor, Finger, Punch Plate and Mesh screen media & combined Finger/ Punch Plate

### FINES CONVEYOR

- 900mm wide belt with impact bars
- Hydraulically folding, angle adjustable
- Tungsten tip scraper

### UNDERSCREEN CONVEYOR

- 1200mm wide belt

### OVERSIZE CONVEYOR

- 1200mm wide chevron belt
- Hydraulically folding with adjustable angle
- 3.6m stockpile height

# PowerScrub™ PS60 / PS60R / PS200 / PS200R

The PowerScrub™ has earned the reputation of being one of the most high performance, robust logwashers available on the market.

The PowerScrub™ range uses two independently driven, counter rotating shafts that allow the logwasher to start-up under load preventing blockages. A combination of high wear resistant blades and paddles in a spiral formation, transition the material through the hull scrubbing the gravel fraction, while water injection allows organics, clays and adhered contaminants to float out the rear.

Equally as comfortable in both sand & gravel and recycling applications, the PowerScrub™ machines can be combined with a range of finishing, sizing and trash screens to form a complete aggregate scrubbing and sizing station.

## FEATURES & BENEFITS

- Designed to produce cleaner material at a faster rate
- Specifically designed to work in the recycling industry, its versatility and design enables it to be easily adapted to work in gravel applications
- Consists of a trough and two spiral axes running counter to one another with exchangeable blades which intensively mix the feed material
- Water used in this process is recirculated to a water treatment facility

## APPLICATIONS

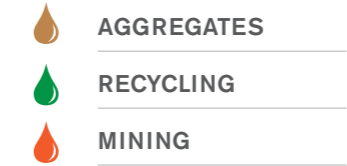

# AggreScrub™

## SCRUB, SIZE, SEPARATE

The AggreScrub™ 150 carries through all the same features of the PowerScrub™ range while adding the benefit of modularity & market leading easy maintenance features. Key benefits for customers include the improved wear characteristics, reduced costs, and the ability to effectively scrub aggregates and float out clays/silts/lights (wood/plastics) on one chassis. In addition, there are also a number of paddle options available depending on customers' needs, including the traditional hard wearing AR blades in 15 and 30mm variants as well as a high manganese steel option.

## FEATURES AND BENEFITS

- Produces up to 4 grades of washed screened aggregate
- Modular design with 'plug and play' electrical connections for quick set-up
- Pre-wired & pre-plumbed with single connection points
- Fully automated touch screen control providing all-round plant information
- Logwasher angle adjustment allows increased material retention and removal of trash
- Choice of replaceable high tensile blades 15mm or 30mm ar, or long-life manganese cast blades to suit your application.
- Transportable in 2 containers

## APPLICATIONS

- AGGREGATES
- RECYCLING
- MINING

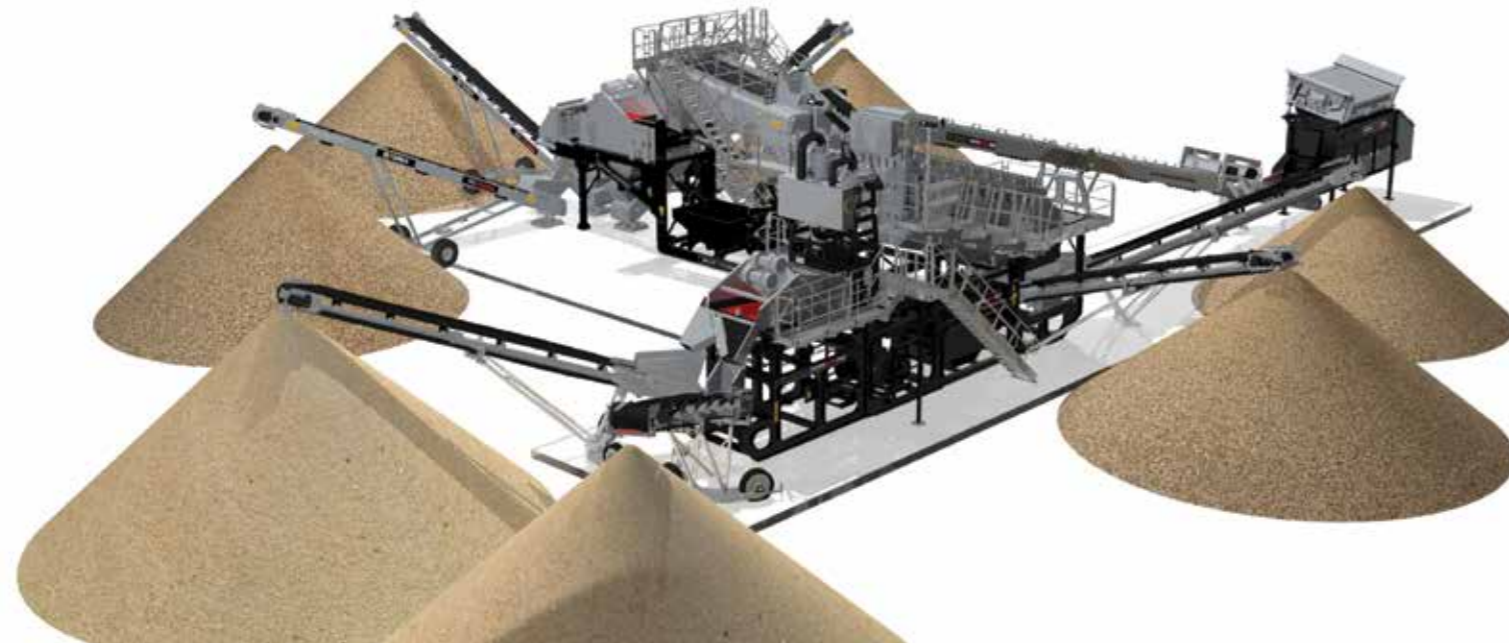

Aggresrub™ working in conjunction with Aggresand™

- Choice of 500 AR Blades OR Long-Life Cast paddles provide high levels of attrition
- Deadbox style chute ensures feed point impact protection for the Aggrescrub shafts
- 1.8m x 0.6m (6' x 2') trash screen for dewatering of lightweight contaminants from logwasher
- Unprecedented complete access around plant with galvanised walkways, access stairs and handrails
- Twin Shaft Logwasher with angle adjustment, to scrub gravel fraction and float out organics & adhered contaminants
- 2 Independent high torque drives allow the logwasher to start-up under load, preventing blockages
- Single water inlet point
- Advanced fully automated control system with remote communication
- Integral sump tank and pump for collection and removal of dirty water
- Wash down hose reel
- Choice of 2.4m x 1.2m (8' x 4') Single Deck or 3.7m x 1.5m (12' x 5') 2 Deck aggregate screen capable of producing up to 4 sized products
- Compact rolling chute assembly for easy access to screen media (Patent Pending)

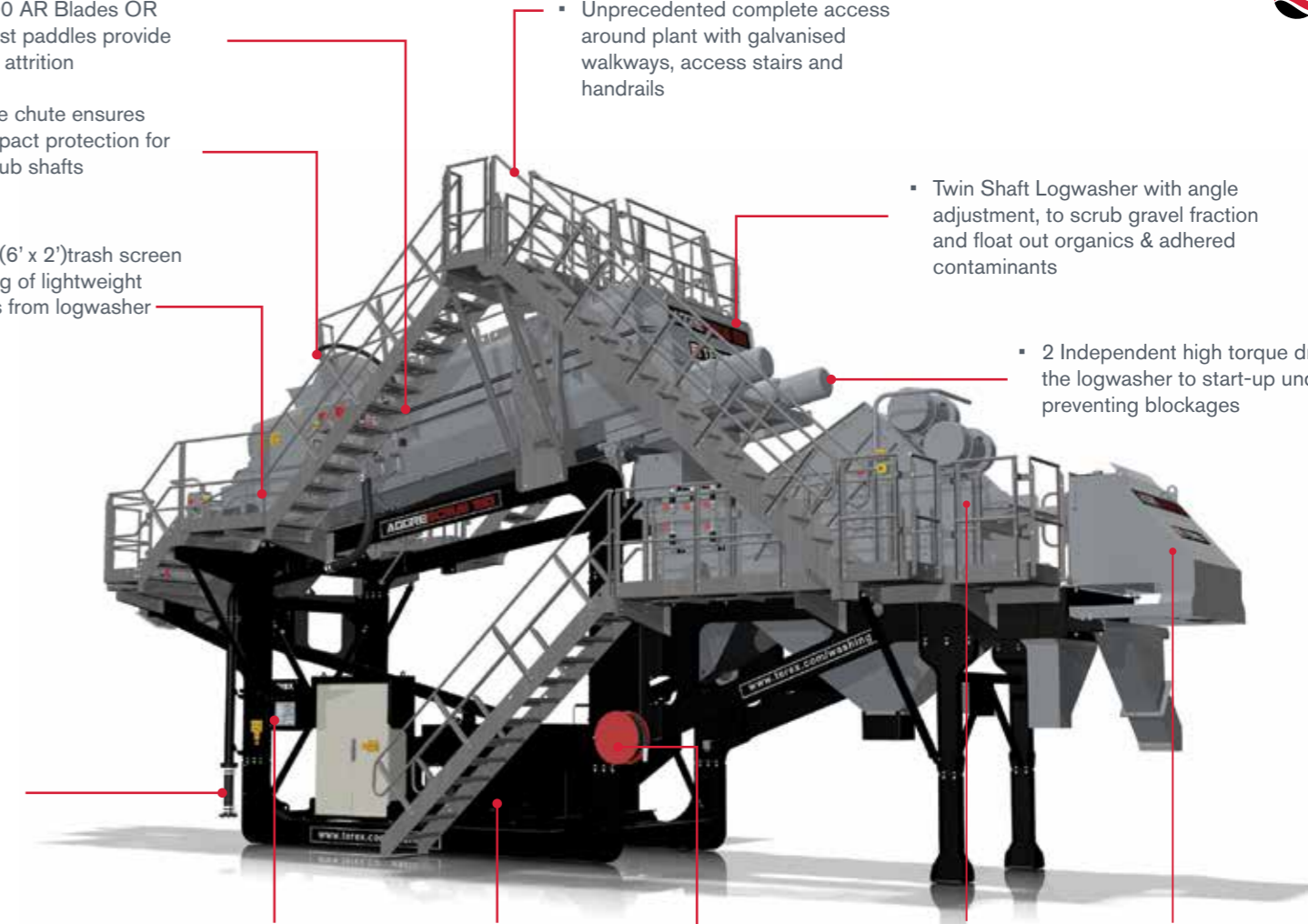

## M RANGE M1400 / M1700 / M2100

With the M-Range™ TWS boasts the widest range of track or wheel mounted, fully mobile washing screens available.

Designed to work independently or with the other TWS range of equipment as part of an entire plant, the M-Range is ideal for short to medium term projects.

The Track mounted M1400 comprising of a feeder, reject grid, feed conveyor, inclined screen and on-board conveyors, offers an excellent entry level robust washing unit with maximum flexibility for integration into a larger plant.

The Track mounted M1700 & M2100 offer the same features on a larger capacity unit, with the added benefits of being available in both 2 and 3-deck.

M-Range machines are available with various engine or dual power electric options.

Capable of producing up to 5 products, they also offer adaption kits to convert to a dry screening application within hours, resulting in the M-series being the most flexible units on the market.

### FEATURES & BENEFITS

- Track mounted mobile washing screens with integrated feed hopper and on-board discharge conveyors
- Quick set up time typically under 15 minutes
- Engine options to suit tier 3 & tier 4 as well as dual power electric drive options
- Hydraulic adjusted screen angle for optimum screening performance.
- Choice of grid and screen media options to suit your application
- Rubber lined catchbox for single or two grades of sand
- Fines conveyor option for dry screening for maximum machine versatility

### APPLICATIONS

-  **AGGREGATES**
-  **RECYCLING**



## Screenbox Range 8x4 / 12x5 / 16x5 / 20x6

The Terex® Screenbox Range is designed for maximum production efficiency in applications including sand and gravel, coal, crushed stone, slag, recycled materials, concrete, iron ore and silica glass.

Available in sizes ranging from 2.4m x 1.2m (8' x 4') up to 6m x 1.8m (20' x 6') all Screenboxes come with the choice of 2 or 3 Decks and a range of media options.

Robust, easy to assemble structures to mount the screen unit are available in a variety of heights to integrate with other TWS equipment. Each structure includes integrated lined discharge chutes, walkways and access steps which can be assembled in a number of configurations to suit your site layout.

### FEATURES AND BENEFITS

- Produces up to 4 grades of washed aggregate and 1 or 2 grades of sand
- High efficiency - low maintenance direct electric drive
- Choice of side tensioned wire mesh or modular polyurethane decks to suit your application
- Isolated spraybars with individual flow valves provides complete water control
- Robust easy to assemble steel support structure, complete with galvanized walkway & handrails provide easy access to any corner of the structure
- Intelligent roll-away chute design allows greater access for media changes
- Extensive rubber lining of all chutes, catchbox and washbox for extended wearlife

### APPLICATIONS

-  **AGGREGATES**
-  **RECYCLING**







**FINESMASTER**

# FM Compact

FM 20 C / FM 60 C / FM 120 C / FM 120 2G / FM 200 C / FM 200 2G

The Terex® FM Compact™ range are static sand recovery units designed to be both cost and energy efficient. The range uses centrifugal force within the cyclone(s) to remove clay, silt and slime from sand to bring it into specification. The range combines a collection tank, centrifugal slurry pump(s), hydrocyclone(s) and a dewatering screen on a single chassis.

**APPLICATIONS**

-  **AGGREGATES**
-  **RECYCLING**
-  **INDUSTRIAL SANDS**

**FEATURES & BENEFITS**

- Can recover 1 or 2 grades of sand from wet feed or bolt-on boiler box option for direct dry feed
- Maximum recovery of saleable material through the removal of silt, slimes and clays below 75µm (200 mesh)
- Robust easy to assemble steel construction complete with galvanized walkway & handrails provide easy access
- Low maintenance & simple operation with self regulating cyclone tank
- Pumps & cyclones have replaceable rubber liners for extended wear life
- High frequency dewatering screen reduces residual water content in your final product to 10–15%
- All electric plant pre-wired to control panel or isolators to integrate with other equipment





# FM Hydro

The FM 60 Hydro™ is the complete sand classification plant combining sand washing and sizing on a single compact structure. The dewatering cyclone in combination with the flat bottom classifier enables the plant to produce 2 in-spec sands from a single feed in point.

**FEATURES & BENEFITS**

- Electronically controlled hydraulic classification system reliably extracts light or small particles from slurry at high efficiency, whilst displacing a minimum of heavy or coarse particles to the overflow
- Direct bed level measurement allows maximum cut point control to produce up to two custom industrial or speciality sands from a single feed
- Multiple water injection nozzles result in uniform water distribution even at minimal flow rates
- The high frequency dewatering screen insures dry, immediately conveyable product for stockpiling
- Electrical control system allows the ability to store up to 5 different settings for rapid change of product specification
- The fully lined classifier has no moving parts exposed to process slurry, meaning little maintenance is required and a long operating life is achievable- Fully lined Flat Bottom Classifier for minimum maintenance

**APPLICATIONS**

-  **AGGREGATES**
-  **RECYCLING**
-  **INDUSTRIAL SANDS**

- Rubber lined 500mm hydrocyclone
- 1.5m flat-bottomed upward current classification unit
- Rubber lined 150/125 pump
- Comprehensive walkway provides access for maintenance
- Completely galvanised walkway
- Electric machine with complete on board PLC control panel
- Single electrical power source required
- Single water inlet source



- HK125 rubber lined dewatering hydrocyclone
- 2.4m x 1.2m (8' x 4') high frequency, linear motion dewatering screen
- Full-width modular polyurethane dewatering media for quick change out
- Polyurethane side modules for superior screen protection.
- Low friction, lined discharge 2 grade chute with angle adjustment and blending capabilities
- Self regulating float level ensures consistent tank volume and pump run-dry protection .
- Tank drainage valves for plant maintenance



FINESMASTER

# FM UltraFines™

The Terex® FM UltraFines™ is a crucial step in efficient management and recovery of ultrafines sand from waste water streams, produced from washing processes.





This ultra-fines recovery unit can process up to 450m<sup>3</sup> per hour of slurry recovering material as low as 40 micron, thus reducing the volume of solids reporting to storage ponds or water treatment plants.

Bringing together a centrifugal pump, a cluster of 4 hydrocyclones and a high frequency dewatering screen on one chassis. The FM UltraFines™ also boasts a uniquely designed conical tank and anti-turbulence system, which is essential in the process of ultra-fines recovery.

## FEATURES & BENEFITS

- Large volume conical tank with bolt on sides
- Removable chassis cover panels for improved serviceability
- Accessible lined pump and motor
- Cyclone array with easy access catch boxes
- Standard 8x4 Dewatering screen
- Fully galvanised, reversible walkways
- 3 Pump options available, dependent on applications

## APPLICATIONS

-  AGGREGATES
-  RECYCLING
-  INDUSTRIAL SANDS
-  MINING

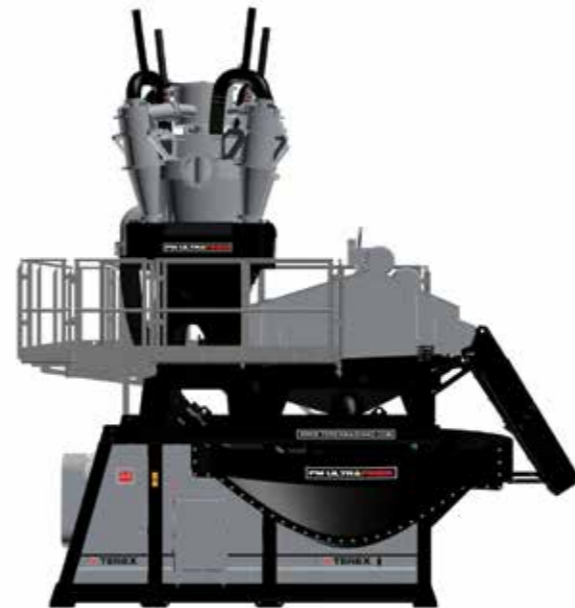

- Cluster of 4 no. T375 cyclones with drop-in replaceable liners
- Single 12" overflow discharge connection

- Fully galvanised access walkways for maintenance of dewatering screen & cyclone spigots.
- Intelligent symmetrical design allows assembly to suit left or right access.

- Single 10" rubber lined feed point can be configured left or right to suit site set up.
- Anti-turbulence feed box provides controlled wearing & reduced settling time.
- Conical tank design eliminates risk of fines build up.
- Bolt-on sides allow simple containerisation and site set-up.
- 200/150 pump complete with 30kW electric motor.
- Replaceable rubber liners for extended wear-life.



▪ Lift out pump feature for easy maintenance.

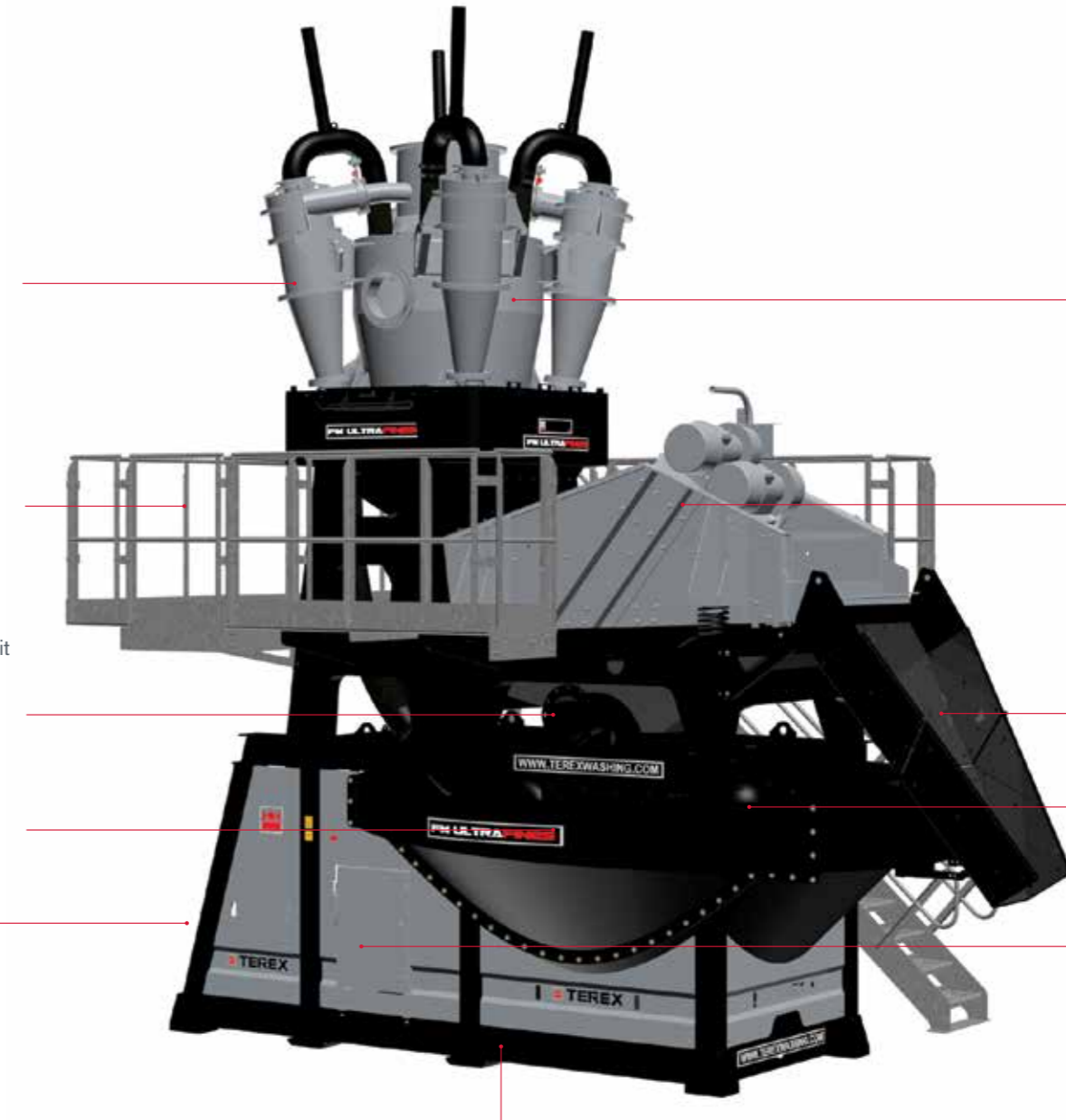

- Fully lined cyclone discharge box for increased wear-life.
- Quick release lids for inspection and maintenance.

- 2.4 m x 1.2m (8'x4') high frequency dewatering screen optimising superior moisture reduction.

- Full width PU media for quick change outs.

- Low friction discharge chute with angle adjustment.

- Self regulating float level system provides consistent tank volume and pump run-dry protection.

- Wired to isolators or fully enclosed control panel to integrate with other TWS equipment.

- Raised chassis design for wash down.



## FINESMASTER

# FM Direct Feed FM 60DF / FM 200DF

The FM Direct Feed™ allows economical washing and sand processing to happen on a very small footprint. The unit is suitable for pre-screened material with minimum oversize and is especially suited to dust washing applications.

The FM Direct Feed is a compact sand plant that works on the principle that a dry pre-screened feed is delivered to the wash box equipped with a high pressure spray bar to pre-soak the feed before being delivered to the screen.

It has been introduced for applications where the percentage of oversize in the feed material is minimum.

### FEATURES & BENEFITS

- Can produce 1 rinsed aggregate and 1 grade of sand (or 1 coarse sand and 1 fine sand) from a single dry feed material
- Maximum recovery of saleable material through the removal of silt, slimes and clays below 75µm (200 mesh)
- Robust easy to assemble steel construction complete with galvanized walkway & handrails providing easy access
- Low maintenance & simple operation with self regulating sump tank
- Pumps & cyclones have replaceable rubber liners for extended wear life
- High frequency dewatering screen reduces residual water content in your final product to 10–15%
- All electric plant pre-wired to control panel or isolators to integrate with other Terex equipment

### APPLICATIONS

- RECYCLING
- AGGREGATES



## FINESMASTER

# FM 120 CONEXUS

The FM Conexus™ is a modular sand classification plant which incorporates a dewatering and water recovery unit. It has a small footprint and can be quickly set-up. It has the ability to provide two washed sands.

### FEATURES AND BENEFITS

- Modular sand classification, dewatering and water recovery unit
- Small plant footprint
- Automated control system
- Quick setup
- Produce up to 2 washed sands

### APPLICATIONS

- AGGREGATES
- INDUSTRIAL SANDS

- High chrome 450mm hydrocyclone.
- High volume washbox to effectively fluidise the dry feed material prior to screening.
- Self-regulating float level system ensures consistent tank volume and pump rundry protection.
- High frequency dewatering screen delivering superior separation and moisture reduction capabilities.
- 14' x 6' [4.2m x 1.8m] dewatering screen on marshmallow vibration isolation screen mountings.
- Screen configuration offers the ability to produce 1 or 2 grades of washed sand
- Polyurethane screening media
- Independently controlled isolated spray bars

- High torque, direct drive rake for maximum sludge collection.
- 6.8m integrated rake thickener combining sludge thickening and water clarification.
- Thickener design intelligently incorporates a 7m³ clarified water tank.
- Gravity feed from cyclone overflow.



- Modular 12m³ capacity hopper
- 1050mm variable speed belt
- 4.3m (14') wide manual tipping grid
- Fully galvanised walkways providing comprehensive access to the plant
- Raised chassis for ease of machine wash down
- Two grade chute with blending capabilities
- Product conveyors with variable angle adjustments.
- 260m³ stockpile capacity (at 18 degrees)
- 1800L, dual compartment flocculant preparation and dosing system.
- Fully automated controls.
- Optional real time flocculant dosing controller reduces flocculant by up to 30%.



FINESMASTER

# FM Bucket Wheel FM 120 BW / FM 200 BW

The Terex® FM Bucket Wheel™ range of sand classification systems are highly efficient dewatering units.

The unit removes silts, slimes and clays from sand to produce up to 2 saleable products in applications including concrete, mortar and asphalt sands, quarry dust/crushed fines, lake and beach sands, silica sand, golf course sands, filter bed sands, recycled materials and iron ore.

The range combines a dewatering bucket wheel(s), a centrifugal slurry pump, hydrocyclone(s), a collection tank and a dewatering screen on a single chassis.

**FEATURES AND BENEFITS**

- Can recover 1 or 2 grades of sand from wet feed or bolt-on boiler box option for direct dry feed
- Maximum recovery of saleable material through the removal of silt, slimes and clays below 75µm (200 mesh)
- Variable speed bucket wheel processes 80-90% of material, reducing wear on the rubber lined pumps & cyclones
- Major reduction in fine material discharging to the water management system, thus reducing recovery cycle and cost
- Low maintenance & simple operation with self regulating sump tank
- High frequency dewatering screen reduces residual water content in your final product to 10–15%
- All electric plant pre-wired to control panel or isolators to integrate with other Terex equipment

**APPLICATIONS**

- 🔴 **AGGREGATES**
- 🟢 **RECYCLING**
- 🟡 **INDUSTRIAL SANDS**



# Bucket Wheel Sand Plants T 150

The Terex® T Range are mobile bucket wheel dewaterers complete with fines retention screw, twin bucket wheel designed units for the removal of clays, silts and slimes to produce up to 2 grades of sand.

The T Range is designed to operate with maximum versatility and can support different requirements such as maximum retention of fines or maximum disposal of fines.

The T Range can be driven hydraulically from the M Range or from its own optional electric power pack.

**FEATURES AND BENEFITS**

- Can recover 1 or 2 grades of sand from wet feed or bolt-on boiler box option for direct dry feed
- High capacity variable speed twin bucket wheel providing increased drainage time for a drier product
- Deep fluted variable speed fines screw provides excellent fines recovery
- Anti-turbulence inlet boxes and weir discharge system allows consistently calm settling conditions
- Can be powered electrically or can be hydraulically coupled to an m-range mobile screen
- Low running costs, low maintenance & simple operation
- Static or site transportable with jacking legs and towbar

**APPLICATIONS**

- 🔴 **AGGREGATES**
- 🟡 **INDUSTRIAL SANDS**



## Mobile Sand Screw Plants M165S / M166S / M206S

TWS offer a range of sand screw options to fit your needs. The screens range in size from 5' x 16' to 6' x 20', and are teamed with single or twin dewatering screws. The screens are outfitted with strategically placed nozzles to scrub materials clean.

High capacity dewatering screws deliver the fine aggregates while chutes and cross conveyors deliver the sized products. The portable chassis design is easy to transport to the desired site and easy to set up.

### FEATURES AND BENEFITS

- Triple deck inclined screen produces 3 grades of washed aggregate and 1 grade of sand
- Each spraybar has individual flow valves provided for complete water control
- Heavy duty single or twin dewatering screws (36" x 25") for high capacity fines recovery.
- Robust I-beam construction chassis with double or triple axle suspension allowing for easy transportation and quick set-up
- All electric plant pre-wired to control panel or isolators to integrate with other Terex equipment
- Walkway access around three sides of the screen
- Integrated drainage and washout features for easy maintenance



### APPLICATIONS

- RECYCLING
- AGGREGATES

## Sand Screw Plants SW100 / SW200

The Terex® SW 100 Sandscrew is a single screw fine material washer/classifier/dewaterer. The recommended maximum material size is 3/8" (10mm). The approximate capacity of the SW 100 Sandscrew is 50-100 TPH. The Terex® SW 200 is a twin screw fine material washer/classifier/dewaterer. The recommended maximum material size is 3/8" (10mm). The approximate capacity of the SW 200 Sandscrew is 100-200 TPH.

### FEATURES AND BENEFITS

- Heavy duty single or twin dewatering screws (36" x 25") for high capacity fines recovery.
- Robust easy to assemble steel construction
- Independent electric drive on each screw for maximum torque under load
- All electric plant which can easily integrate with other Terex equipment
- Low maintenance & simple operation

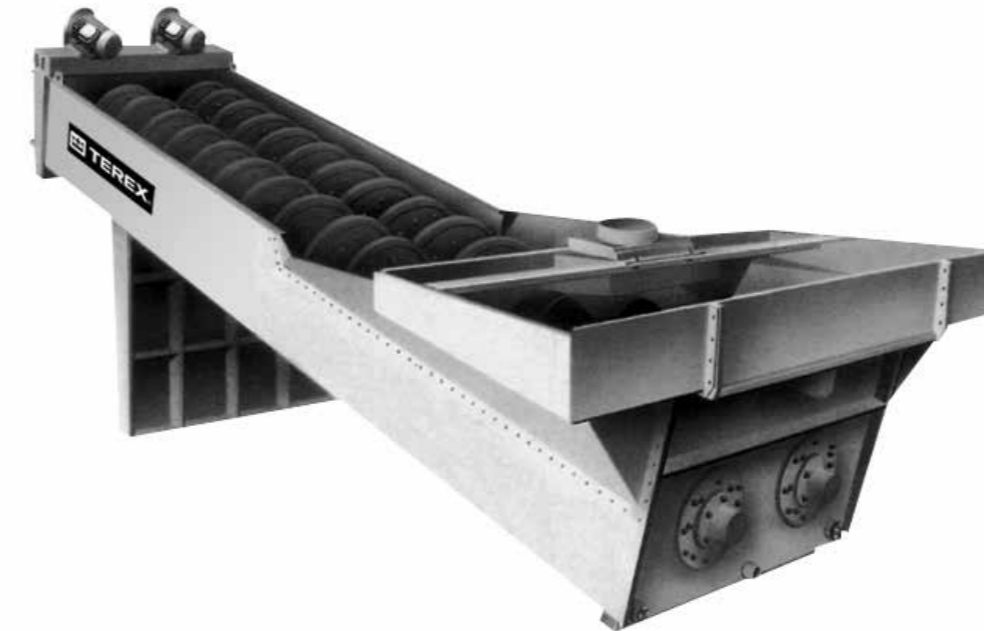

### APPLICATIONS

- RECYCLING
- AGGREGATES

## FracPro 150 / 300 / 500

Terex Washing System's FracPro™ range enables a clean, in-spec sand to be produced for the industrial hydraulic fracturing market. The modular FracPro™ range incorporates, washing, screening and sand classification through a double-wash system to accomplish a high-quality, industrial product for the Frac industry. The intelligent TWS design and pre-assembled, factory machine ensures a quick and easy build procedure and the inclusion of Terex's AquaClear range results in the full solution.

### FEATURES AND BENEFITS

- Hopper and Feed Conveyor
- 206 Rinsing Screen
- Oversized Conveyor
- Large Volume Sump Tank and Pump
- Localised MCC

### HYDROCYCLONE SAND PLANT:

- Built in Double Wash System
- High Frequency Dewatering Screen
- Sand Transfer Conveyor

### AQUACLEAR:

- Deep Cone Thickener
- Flocculent Dosing System
- Homogenising Tank
- Filter Press
- Clarified Water Tank

### APPLICATIONS



RECYCLING



INDUSTRIAL SANDS

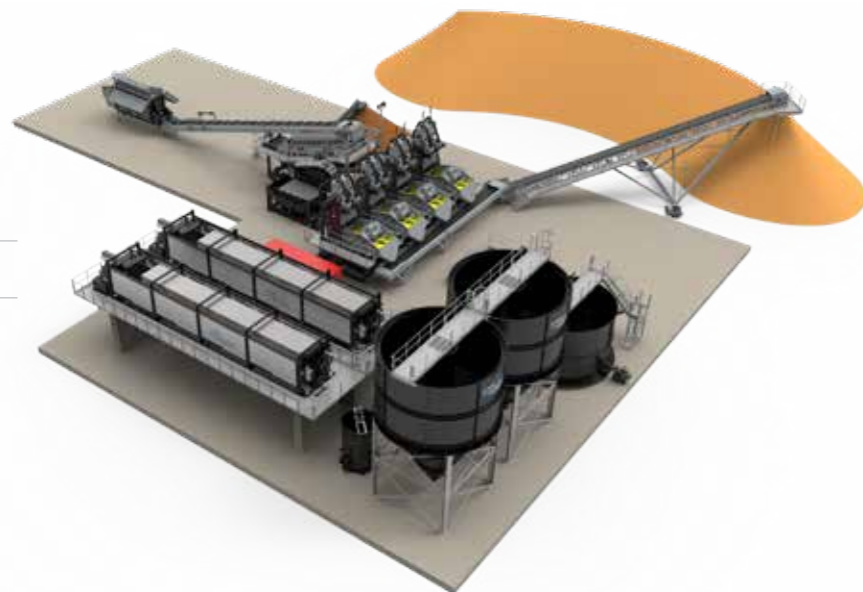

## Attrition Cells

Attrition Scrubbers, also known as Attrition Cells, are used to liberate deleterious material and remove it from competent aggregate material. They are also proven to liberate clays, reducing product turbidity, and to break apart loosely conglomerated clusters in sand.



This style of scrubber is ideal for industrial (frac, glass, sports) and mineral sands to meet turbidity and color test requirements. They also allow more efficient downstream separation, such as in flotation and electrostatic/electromagnetic separation. Attrition Cells can handle high plasticity clays in high shear and aggressive scrubbing environments.

## H RANGE H 9 \ H12 \ H 20 \ H 25

A stand alone hopper designed to provide a constant feed of material to TWS Washplants. A range of different options are available to suit your requirements.

### FEATURES AND BENEFITS

- Heavy-duty robust construction ideal for rugged operating environment
- Can be powered electrically or can be hydraulically coupled to an optional electric Hydraulic Powerpack for complete feed control
- Choice of Hydraulic Tipping Reject Grid or Double Deck Vibrating Grid to suit your application
- Self cleaning grid bars available in a variety of apertures from 75mm up to 200mm
- Hopper Extensions and Liners available for increased capacity and wear resistance
- Intelligent hinged maintenance access
- Integrates seamlessly with other TWS product

### OPTIONS

- Impact rollers
- Wear plates
- Adjustable hopper door
- Single & double deck vibrating grid
- Hopper extensions
- Radio control tipping

### APPLICATIONS



AGGREGATES



RECYCLING



INDUSTRIAL SANDS



MINING



# AggreStac™ 65 / 80 / HLF 75 / LLF 75

The Terex® AggreStac™ is an ideal addition to any Sand or Aggregate processing plant.

This range of Track Mounted diesel powered Stockpiling Conveyors are available in lengths of 65ft or 80ft with the capacity to stockpile up to 400TPH. The compact design allows each unit to transport inside one 40ft container with full hydraulic fold out features for set-up.

With hydraulically adjustable feed and discharge heights, and a range of feedboot linings and extensions the AggreStac allows maximum flexibility to integrate into any existing plant set-up.

## FEATURES AND BENEFITS

- Self powered diesel hydraulic tracked conveyor
- Full hydraulic set-up, no crane required
- Containerized, track-in/track-out
- Compact folding mechanism allows intact containerisation
- Hydraulic adjustment for variable feed height reduces impact and provides optimal material transfer
- Steel lined feedboot as standard providing extended wear life. Feedboot extensions and rubber lined options also available.
- Hydraulic angle adjustment from 0° to 28° for easy plant integration.
- Fully protected powerunit with easy access for service and maintenance
- Dual-speed tracks for quick and controlled deployment

## APPLICATIONS

- AGGREGATES
- RECYCLING
- INDUSTRIAL SANDS
- MINING



With 400mm dual speed tracks as standard the AggreStac offers speed and control during installation across any terrain



Optional feedboot extensions and liners available to suit a variety of applications



With different scraper and secondary guarding options, the AggreStac can be customised to suit various applications in various regions



The fully enclosed powerunit offers maximum protection while allowing easy access for daily maintenance

# TC Conveyors TC 6532 / TC 5032 / TC 4026

The Terex® TC range of conveyors are an integral part of the TWS product range and are constructed to the same high engineering specification. The low-profile, compact design allows portability and versatility, enabling these conveyors to work in compact plant layouts.

The TC range is designed to integrate seamlessly with all the TWS products and are available with either hydraulic or electric drive options.

## FEATURES AND BENEFITS

- Capable of handling up to 300tph
- Mobile unit with towbar and road wheels
- Large stockpile capacity
- Manual hand pump for height adjustment
- Detachable pivot stand and towbar

## APPLICATIONS

- AGGREGATES
- RECYCLING
- INDUSTRIAL SANDS
- MINING



# Modular Lattice Conveyors





TWS also offer a range of Modular Lattice conveyors. The intelligent modular design provides belt width options from 500mm up to 1200mm, and the ability to add options such as maintenance platforms and walkways to both sides depending on the application needs.

Electric driven and galvanised as standard, these conveyors can be used as static primary feed or transfer conveyors, or as radial stockpiling conveyors up to 34m in length.

## FEATURES AND BENEFITS

- Capable of handling up to 300tph
- Mobile unit with towbar and road wheels
- Large stockpile capacity

## APPLICATIONS

-  **AGGREGATES**
-  **RECYCLING**
-  **INDUSTRIAL SANDS**
-  **MINING**



# WATERPUMPS

## FRESH WATER PUMPS

TWS has a dedicated team of engineers focused on developing applications solutions. Our engineers analyse project requirements to help determine equipment and cost efficiency whatever your pumping requirements. Our cast iron pump has a hard face mechanical seal, mounted on a mild steel base and includes an integrated prime tank

## FEATURES AND BENEFITS

- Pump at pressures up to 5.5 bar (80 Psi)
- Horizontal close coupled end suction
- Double shrouded single entry radial flow impeller
- Rubber bellows type mechanical seal
- Foot valve & strainer
- Flexible suction – 6m long
- Ease of maintenance
- Low running costs
- Self priming Water tank
- Heavy duty steel construction

## VERTICAL SHAFT SLURRY PUMPS

The TWS Vertical shaft slurry pump range provides substantial performance with low power consumption making it one of the lowest running cost pump of its class.

## FEATURES AND BENEFITS

- Designed for tough applications, primarily
- Designed for difficult applications requiring agitation to ensure no solids build up
- Large particle size
- High density slurries
- Continuous or “snore” operations
- Integrated impeller agitation vanes prevent sump pump blockage
- With only three major components, fewer assembled parts make for ease of maintenance.
- High wear resistant parts are used to provide long wear life
- No priming required
- No submerged bearings

## APPLICATIONS

-  **WATER MANAGEMENT**





TWS offers a complete tailored solution for water treatment and management, including a full range of filter presses, flocculant dosing systems and thickening tanks. Combined this equipment can remove the need for settling ponds.

It is critical that systems are selected appropriate to your specific materials, as requirements can be refined according to your specific needs. This includes qualified sampling and testing to ensure complete peace of mind for performance and the ability to handle inevitable feed variations.

Intelligent automation is common throughout our equipment range and this is particularly relevant to water management systems. The majority of our systems include fully automated control and adjustment of the flocculant dose, according to the amount of suspended solids and settlement time required. This ensures maximum performance even with highly variable feed materials such as recycled sources and eliminates any risk of over-dosage.

Our wide choice of thickener models and formats ensures you are offered the best solution for your individual needs, all with low operational cost and maximum dewatering in mind. Following the thickener you have a choice of filter presses, again depending upon your individual material characteristics and performance needs.

**FILTERPRESSES**

Filter presses are based on a simple and ancient principle invented by the Romans to press olives and grapes. Today's technology makes it an essential tool for many industries.

TWS filter presses use high pressure pumps in order to squeeze water out of the sludge, recovering up to 95% of the water. Remaining solids are pressed into dry slabs, 'filter cakes', which can be easily handled; ready for reuse or disposal. Filter presses are the ideal complement to wash-plants operating in the aggregates, mining and recycling industries.

**FEATURES AND BENEFITS**

- 100% Fully Automatic
- High pressure pumps to filter sludge. Produces extremely dry cake.
- Utilising only highest quality components
- Up to 95% recovery of water
- Up to 80% reduction in silt handling and transport costs

**THICKENERS**

TWS offers a range of Thickener sizes and types to suit a variety of materials and applications. The TWS Applications team balance the client's needs in terms of material type and slurry volume, desired sludge characteristics in order to propose the best thickener for each project.

**DEEP CONE THICKENERS**

Deep cone thickeners are based on static decantation principles allowing for minimal footprint and virtually no moving parts. The deep cone and cylinder section imparts a greater pressure head on the settled slurry thus producing a higher percentage solids content than that of a standard rake thickener.

**FEATURES AND BENEFITS**

- Produces thick mud at 50% solids
- Reduced cost for concrete basement
- Extra stock for mud
- Extremely low operating cost
- Non-moving parts
- No extraction pump required
- Low maintenance costs
- Combined thickening and clarification

**RAKE THICKENERS**

TWS also offers a range of rake style, high rate thickeners which allow for minimal feed height, facilitating gravity feed from upstream cyclone based washing systems.

Rake thickeners are designed specifically to deal with high volumes of slurry. The integral scrapers aid transportation of material from the outskirts of the tank to the outlet, thus accelerating the removal of sludge from the thickener.

**FEATURES AND BENEFITS**

- Produces sludge with 30 - 40% solids content
- Lower level feed in height
- Can handle high volumes of slurry
- Extra stock for slurry
- Combined thickening and clarification

**FLOCCULANT DOSING SYSTEM**

TWS flocculant dosing systems control the amount of chemical flocculant required to achieve the most rapid settling times within the thickener tank. The automatic dosing system enables the unit to adjust the flocculant dosage dependent on the feed material and solids content, thus reducing wastage and ensuring the correct dose is added continually.

**FEATURES AND BENEFITS**

- Automatic dosing system
- Stainless steel construction
- Dry or emulsion based polymer system
- Reduced flocculant consumption by up to 30%



Filter Cakes

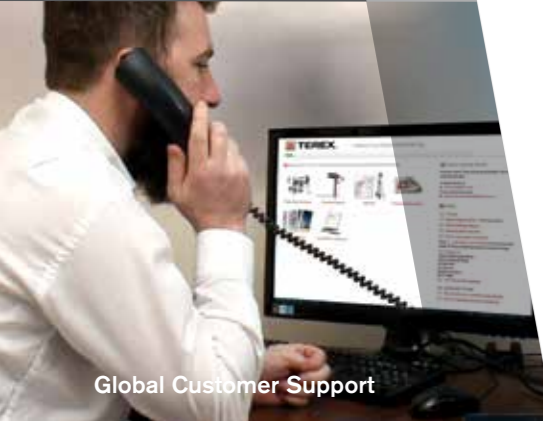

Global Customer Support

Delivering on our promises, so you can keep yours.

**OUR GROWING GLOBAL NETWORK**

- 1 West Oahu Aggregate, Hawaii
- 2 Fort Lauderdale, Florida, USA
- 3 Sunrock Quarry, Kittrel, North Carolina, USA
- 4 Readymix, Trinidad
- 5 Dowling Quarries, Ireland
- 6 R. Collard Ltd, England, UK
- 7 Paterson Quarries, Scotland, UK
- 8 J.C. Ball, Hillhead, England, UK
- 9 Santrac, Chambellay, France
- 10 Geddes Group, Scotland, UK
- 11 Lafarge Concrete, England, UK
- 12 Terex Facility India
- 13 Terex Facility Malaysia
- 14 Dubbo Sands, Australia

1



Georgette Silva, President West Oahu Aggregate, Hawaii

"We received an excellent service from the dealer and we are very happy with the AggreSand™, which is a very reliable piece of equipment and produces nice clean material"

2



John Dixon, President Virginia Sand and Stone, Virginia, USA, Florida Customer Open Day.

"Our customers are absolutely thrilled with the product, the support has been phenomenal. TWS is the way for anybody who is looking for a sand operation, they have proven themselves to us over the years but they have really hit the mark with this new AggreSand™"

3



Mark Keenan, Sales Manager, Powerscreen Mid-Atlantic

"The ease of setup and installation, due to its modular design, enables us to provide the customer with a complete turnkey solution, which can be moved from one site to another in a short space of time"

4



Ravi Singh, Quarry Manager, ReadyMix, Trinidad

"This TWS wash plant has much lower maintenance costs, has maximum efficiency and productivity and allows us to be ultimately much more competitive in the market place."



Robert Collard, Managing Director, R. Collard Ltd., England

"Very impressive piece of kit, producing some very nice material which opens up a whole new opportunity and new market for us."



Humphry Dowling, Owner Dowling Quarries, Ireland

"The plant is a quick set-up, doing good tonnes per hour, we can put material directly from the face of the quarry straight into the plant and get a finished product on the ground"

5

6

7

8

9

10

11

12

13

14

15

16

17

18

19

20

21

22

23

24

25

26

27

28

29

30

31

32

33

34

35

36

37

38

39

40

41

42

43

44

45

46

47

48

49

50

51

52

53

54

55

56

57

58

59

60

61

62

63

64

65

66

67

68

69

70

71

72

73

74

75

76

77

78

79

80

81

82

83

84

85

86

87

88

89

90

91

92

93

94

95

96

97

98

99

100

101

102

103

104

105

106

107

108

109

110

111

112

113

114

115

116

117

118

119

120

121

122

123

124

125

126

127

128

129

130

131

132

133

134

135

136

137

138

139

140

141

142

143

144

145

146

147

148

149

150

151

152

153

154

155

156

157

158

159

160

161

162

163

164

165

166

167

168

169

170

171

172

173

174

175

176

177

178

179

180

181

182

183

184

185

186

187

188

189

190

191

192

193

194

195

196

197

198

199

200

201

202

203

204

205

206

207

208

209

210

211

212

213

214

215

216

217

218

219

220

221

222

223

224

225

226

227

228

229

230

231

232

233

234

235

236

237

238

239

240

241

242

243

244

245

246

247

248

249

250

251

252

253

254

255

256

257

258

259

260

261

262

263

264

265

266

267

268

269

270

271

272

273

274

275



## AUTOMATION & CONTROL

For some material washplants, simplicity is key. In these cases we provide basic 'relay-logic' control panels to control and protect the main components such as motors, pumps and valves. However, when more advanced plants are required, TWS offers fully automated solutions using Programmable Logic Control Systems (PLC) and Human Machine Interfaces (HMIs). All software and hardware is developed in-house by our electrical systems team using strict design, develop and test procedures to help ensure systems are developed in line with all relevant safety standards and exceed customers' expectations in terms of ease of use and performance.

Fully integrated radio control and remote telemetry systems are also available to further simplify and enhance the operation of the plant and provide the customer with real-time data such as operational status, active alarms and tonnage per hour.



Central control panel for typical large washplant installation



Aggresand™ Control Panel



Local machine control panel



H12 Feeder Control Panel



## FINANCE SUPPORT FOR YOU

Perhaps the only thing more comprehensive than our vast product line is our wide range of effective finance and leasing solutions, structured to complement customers' cash flow and budgets.

Our team of finance professionals knows the importance of working closely with your customers to understand the unique challenges of their business and their financial goals and requirements. Obtaining financing is often a time consuming task, so we work hard to provide a reliable, flexible and responsive service.

The Terex® Financial Services™ (TFS) team can help assist in all areas of asset management, from the analysis of future equipment values through the disposition of used equipment.

TFS is part of the Terex® family, so you'll work directly with financial professionals who understand your business and can help you get the equipment you need with financial solutions based on your business goals and objectives.



**TFS is a one-stop shop for effective financing solutions:**

- **Trade-in Programs — we'll work with you to get you out of your existing equipment and into new Terex® equipment**
- **Helping you manage cash flow and conserve working capital**
- **Ownership and lease options**
- **Much, much more**

Build the fleet you want with competitive financing rates, as well as special lease and purchase options from TFS. It's a great way to have the equipment you need while managing your cash flow.

**Contact: [TWS.sales@terex.com](mailto:TWS.sales@terex.com) to discuss finance packages available to you**



A large, white, stylized water drop graphic that occupies the right side of the page. It has a smooth, rounded bottom and a sharp point at the top. Inside the drop, the text "Washing as it should be" is centered.

Washing as it  
should be

TEREX WASHING SYSTEMS

Headquarters, 32 Farlough Road, Dungannon, Northern Ireland, BT71 4DT

Tel: +44(0) 28 8771 8500 Email: TWS.Sales@terex.com

[www.terex.com/washing](http://www.terex.com/washing)

