



TRAKPACTOR 230

The Powerscreen Trakpactor 230 is a compact impact crusher which has been designed to offer both excellent reduction and high consistency of product yield. With its compact design and ease of mobility, the Trakpactor 230 is primarily suited to recycling, demolition and mining applications.



✓ APPLICATIONS

AGGREGATE



Blasted rock
River rock

RECYCLING



C & D waste
Foundry waste

MINING



Processed ores
Processed minerals



TECHNICAL HIGHLIGHTS ✓

SUPERIOR PRODUCTIVITY

- Proven impact crusher with hydraulic overload protection
- Fully enclosed hopper to eliminate spillage
- HPTO clutch & highly fuel efficient direct drive system
- Powerscreen Pulse intelligent monitoring as standard

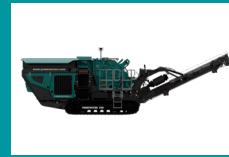

VERSATILITY

- Suitable for a range of different feed materials
- Comprehensive list of custom options are available to meet the exact crushing requirements of each customer



SERVICEABILITY

- Excellent, unrestricted access to all key maintenance points
- Product conveyor can be lowered during operation to avoid blockages and can be removed when servicing





TECHNICAL SPECIFICATION

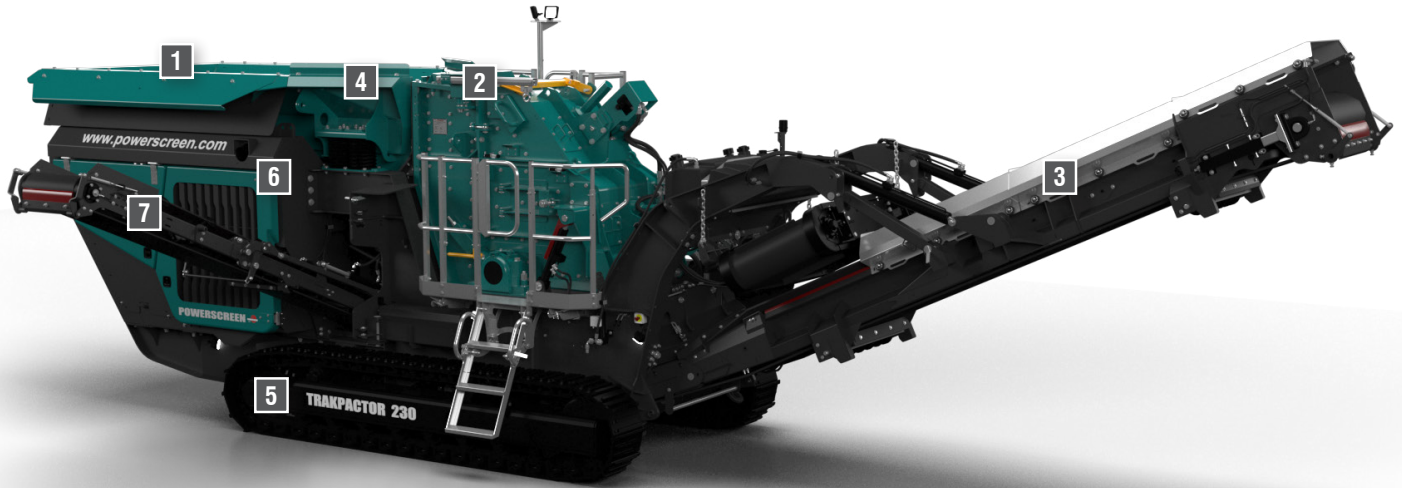

1 HOPPER

Length: 3.6m (11'10")
Width: 2m (6'7")
Capacity: Up to 2.6m³ (3.4 cu. Yd.)

2 CRUSHER

Feed Opening: 860mm x 720mm
(34" x 28")
Min. CSS: 40mm (1.5")* upper apron
Min. CSS: 20mm (0.75")* lower apron

3 PRODUCT CONVEYOR

Width: 900mm (36")
Discharge height: 3m (9' 10")

4 FEEDER

Vibrating grizzly feeder
Screening Area: 1080mm x 810mm
(3'7" x 2'8")
Length: 3.6m (11'10")

5 TRACKS

Width: 400mm (1' 4")

6 POWER UNIT

Tier 3 / Stage 3A: John Deere 6068
194kW (260hp)
Tier 4F / Stage 4: Volvo D8 210Kw
(281hp)
Fuel tank capacity: 300L (79 US GAL)

7 BYPASS CONVEYOR (OPTION)

Width: 500mm (20")
Discharge Height 2.4m (7'10")
Hydraulically folds for transport



DIMENSIONS

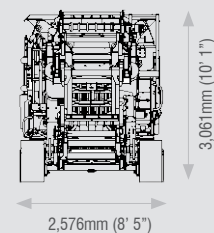
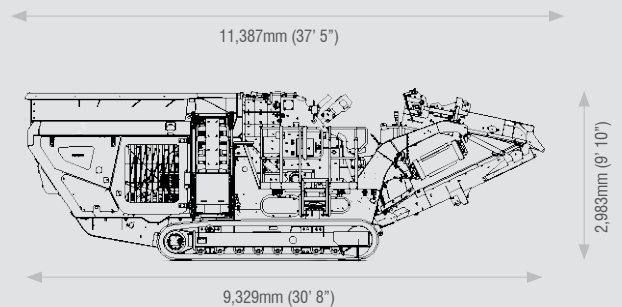
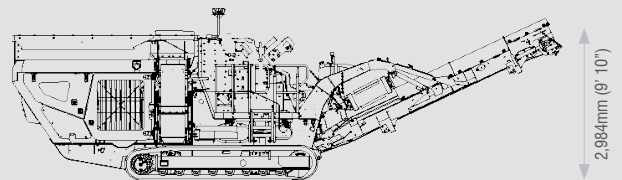

GET IN TOUCH

Dungannon
200 Coalisland Road, Dungannon,
Co Tyrone, BT71 4DR, Northern Ireland
Tel: +44 (0) 28 87 718 500
Fax: +44 (0) 28 87 747 231

Louisville
11001 Electron Drive,
Louisville, Kentucky, 40299 USA
Tel: +1 502 736 5200
Fax: +1 502 736 5202



www.powerscreen.com

The material in this document is for information only and is subject to change without notice. Powerscreen assumes no liability resulting from errors or omissions in this document, or from the use of the information contained herein. Due to continual product development we reserve the right to change specifications without notice. Product performance figures given in this brochure are for guidance purposes only, this information does not constitute an expressed or implied warranty or guarantee, but shows test examples provided by Dealers. These results will vary depending on crusher chamber settings, screen media and sizes, feed source and types of material being processed. Photographs are for illustrative purposes only, some or all of the machines in the illustrations may be fitted with optional extras. Please check with your Dealer for details on optional extras. All machines are CE Approved.

Powerscreen® is a registered trademark of Terex GB Limited in the United States of America and many other countries. Copyright 2020 Terex GB Limited. Published and Printed in January 2020.



TRAKPACTOR 230SR

The Powerscreen Trakpactor 230SR is a compact impact crusher which has been designed to offer both excellent reduction and high consistency of product yield. With its compact design and ease of mobility, the Trakpactor 230SR is primarily suited to recycling, demolition and mining applications.

A post-screen system and recirculating conveyor allows oversize material to be passed back to the crusher or further sizing.



✓ APPLICATIONS

AGGREGATE



Blasted rock
River rock

RECYCLING



C & D waste
Foundry waste

MINING



Processed ores
Processed minerals

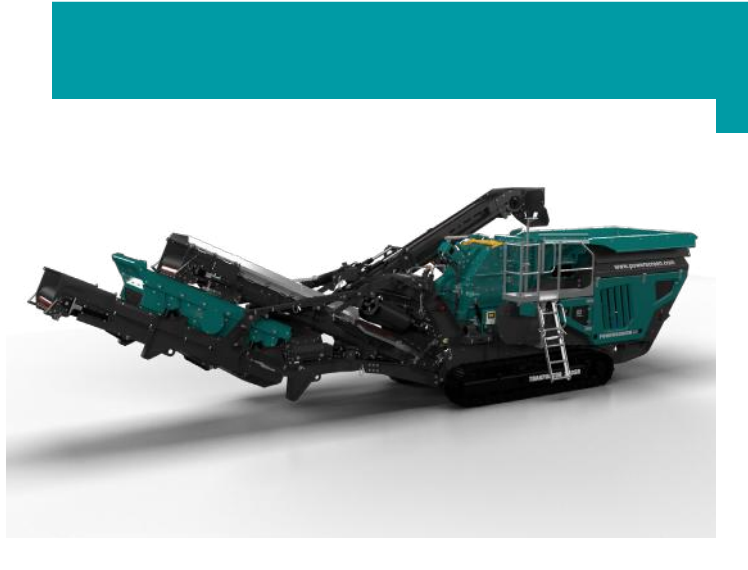

TECHNICAL HIGHLIGHTS ✓



SUPERIOR PRODUCTIVITY

- Proven impact crusher with hydraulic overload protection
- Fully enclosed hopper to eliminate spillage
- HPTO clutch & highly fuel efficient direct drive system
- Powerscreen Pulse intelligent monitoring as standard



VERSATILITY

- Converts to the Trakpactor 230 in minutes thanks to quick-detach SR section. Ideal for regions with transport weight restrictions
- Recirculating conveyor slews hydraulically from recirculation to stockpiling mode



SERVICEABILITY

- Excellent, unrestricted access to all key maintenance points
- Product conveyor can be lowered during operation to avoid blockages and can be removed when servicing





TECHNICAL SPECIFICATION

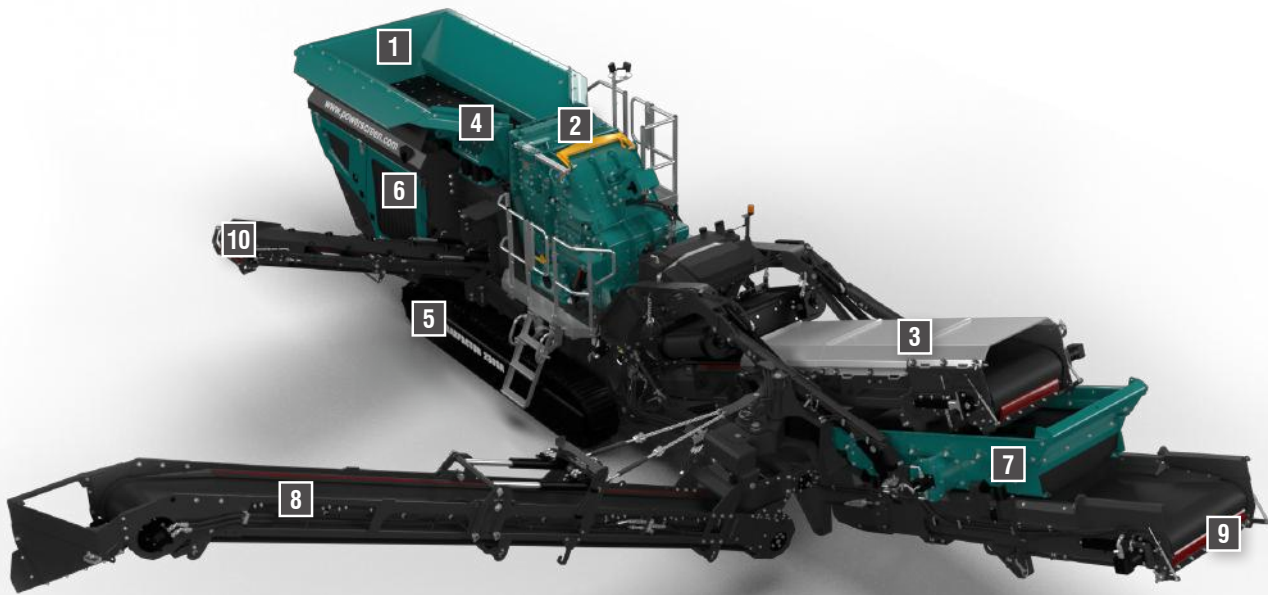

1 HOPPER

Length: 3.6m (11'10")
Width: 2m (6'7")
Capacity: Up to 2.6m³ (3.4 cu. Yd.)

2 CRUSHER

Feed Opening: 860mm x 720mm
(34" x 28")
Min. CSS: 40mm (1.5")* upper apron
Min. CSS: 20mm (0.75")* lower apron

3 PRODUCT CONVEYOR

Width: 900mm (36")
Discharge height: 3m (9' 10")

4 FEEDER

Vibrating grizzly feeder
Screening Area: 1080mm x 810mm
(3' 7" x 2' 8")
Length: 3.6m (11' 10")

5 TRACKS

Width: 400mm (1' 4")

6 POWER UNIT

Tier 3 / Stage 3A: John Deere 6068
194kW (260hp)
Tier 4F / Stage 4: Volvo D8 210kW
(281hp)
Fuel tank capacity: 300L (79 US GAL)

7 POST SCREEN

Single deck screenbox
Top deck: 2.44m x 1.2m (8' x 4')
Drive: Hydraulic motor

8 RECIRCULATING CONVEYOR

Width: 500mm (20")
Discharge height: 3.1m (10' 4")

9 FINES CONVEYOR

Width: 1000mm (40")
Discharge height: 2.5m (8' 2")

10 BYPASS CONVEYOR (OPTION)

Width: 500mm (20")
Discharge height: 2.4m (7' 10")
Hydraulically folds for transport



DIMENSIONS

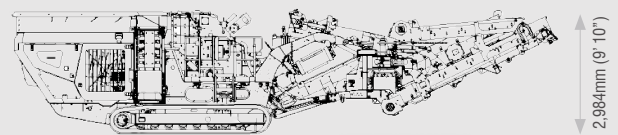

13,388mm (43' 11")

2,984mm (9' 10")

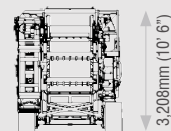

2,657mm (8' 9")

3,208mm (10' 6")

GET IN TOUCH

Dungannon
200 Coalisland Road, Dungannon,
Co Tyrone, BT71 4DR, Northern Ireland
Tel: +44 (0) 28 87 718 500
Fax: +44 (0) 28 87 747 231

Louisville
11001 Electron Drive,
Louisville, Kentucky, 40299 USA
Tel: +1 502 736 5200
Fax: +1 502 736 5202



www.powerscreen.com

The material in this document is for information only and is subject to change without notice. Powerscreen assumes no liability resulting from errors or omissions in this document, or from the use of the information contained herein. Due to continual product development we reserve the right to change specifications without notice. Product performance figures given in this brochure are for guidance purposes only, this information does not constitute an expressed or implied warranty or guarantee, but shows test examples provided by Dealers. These results will vary depending on crusher chamber settings, screen media and sizes, feed source and types of material being processed. Photographs are for illustrative purposes only, some or all of the machines in the illustrations may be fitted with optional extras. Please check with your Dealer for details on optional extras. All machines are CE Approved.

Powerscreen® is a registered trademark of Terex GB Limited in the United States of America and many other countries. Copyright 2020 Terex GB Limited. Published and Printed in January 2020.