



WALKER | 2023

Product Catalogue

New Zealand



WALKER TALK

Customer Profiles

Zeke Rhodes, Page 2

Alex Cembalisty, Page 12

Kory Knutz, Page 30

Eliseo Mauricio, Page 40

Property maintained by Alex Cembalisty of Bay View Turf Specialists from Dighton, Massachusetts.

Table of Contents

Message from Bob Walker	1	Add-ons: Attachments	
Walker Talk Customer Profile: Zeke Rhodes	2	Hard Cab	48
Walker Advantages		Soft Cab	48
Front-Mount Deck	6	ROPS	49
Short Deck Coupling	6	Single-Stage Snowblower 36"	49
Interchangeable Decks and Add-ons	7	Spyker® Spreader Attachment	49
Tilt-Open Bodies and Tilt-Up Decks	7	Dethatcher	50
Grass Handling System® (GHS)	8	Boom Sprayer	51
Integrated Components	8	48" Dozer Blade	51
Precision Steering and Handling	9	48" Model R Dozer Blade	51
Compact	9	Add-ons: Options	
Transmission Oil Performance System (TOPS)™	10	Comfort Seat	52
Kohler PRO 300-Hour Extended Life Oil and Filter	11	Suspension Seat	52
Walker Talk Customer Profile: Alex Cembalisty	12	Armrests	52
Models		Utility Bed	53
Model S	16	Headlights	53
Model C	18	Cup Holder	53
Model T	20	Instrument Panel Cover	53
Model D	22	Power Dump	54
Model R	24	Hi-Dump®	54
Model B	26	No-Catch Deflector	55
Model H	28	Large Hole Screen	55
Walker Talk Customer Profile: Kory Knutz	30	GHS Blower Lockout	55
Decks		Dump Bins	55
Mulching Decks and Kits	34	Dump Bag	55
Collection Decks	35	Deck Height Adjuster	56
Side Discharge Decks	36	Deck Height Washers	56
Rear Discharge Decks	37	Curb Jumper	56
Multi-Deck	38	Power Tilt-Up®	57
Deck Add-ons	38	Deck Lift	57
Deck Compatibility	39	Breakaway Blades	57
Walker Talk Customer Profile: Eliseo Mauricio	40	Deck Cuff	58
Add-ons: Implements		Spread-Axle Tail Wheel	58
Implement Hitch	44	Dual Tail Wheel	58
Option: Tail Weights	44	Single-Wide Tail Wheel	59
Rotary Broom	45	Adjustable Footrests	59
Dozer Blade (48" or 60")	46	Tail Wheel Lock	60
Loader Bucket	46	Big Tire Kit	60
Debris Blower	47	Turf Tires	61
Two-Stage Snowblower (42" or 50")	47	All-Terrain (AT) Tires	62
		Deck Tires	63
		Tire Chains	63
		Add-on Compatibility	64
		Walker Mower Specifications	Back Cover

Go to walker.com to see more information on all Walker products



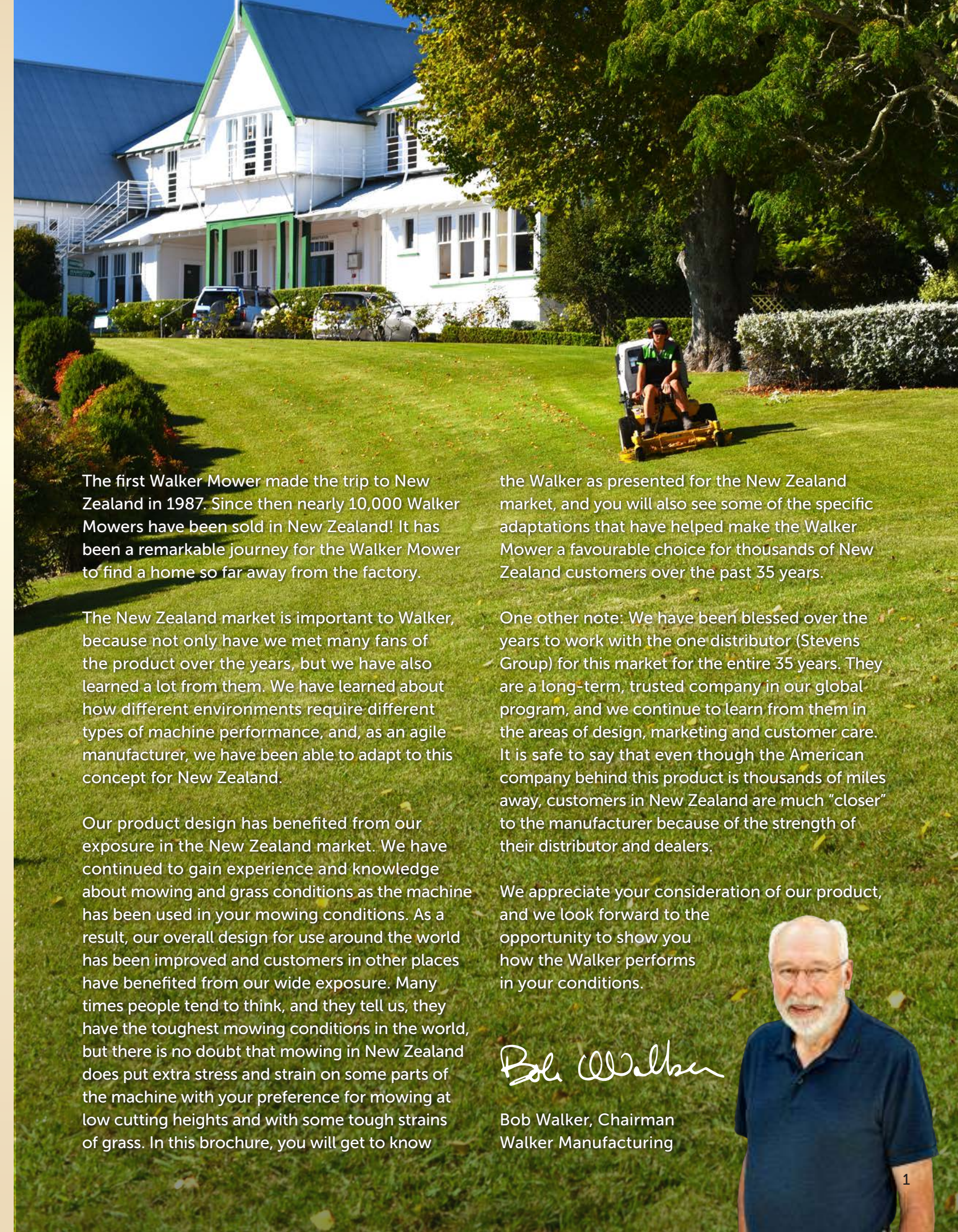

The first Walker Mower made the trip to New Zealand in 1987. Since then nearly 10,000 Walker Mowers have been sold in New Zealand! It has been a remarkable journey for the Walker Mower to find a home so far away from the factory.

The New Zealand market is important to Walker, because not only have we met many fans of the product over the years, but we have also learned a lot from them. We have learned about how different environments require different types of machine performance, and, as an agile manufacturer, we have been able to adapt to this concept for New Zealand.

Our product design has benefited from our exposure in the New Zealand market. We have continued to gain experience and knowledge about mowing and grass conditions as the machine has been used in your mowing conditions. As a result, our overall design for use around the world has been improved and customers in other places have benefited from our wide exposure. Many times people tend to think, and they tell us, they have the toughest mowing conditions in the world, but there is no doubt that mowing in New Zealand does put extra stress and strain on some parts of the machine with your preference for mowing at low cutting heights and with some tough strains of grass. In this brochure, you will get to know

the Walker as presented for the New Zealand market, and you will also see some of the specific adaptations that have helped make the Walker Mower a favourable choice for thousands of New Zealand customers over the past 35 years.

One other note: We have been blessed over the years to work with the one distributor (Stevens Group) for this market for the entire 35 years. They are a long-term, trusted company in our global program, and we continue to learn from them in the areas of design, marketing and customer care. It is safe to say that even though the American company behind this product is thousands of miles away, customers in New Zealand are much "closer" to the manufacturer because of the strength of their distributor and dealers.

We appreciate your consideration of our product, and we look forward to the opportunity to show you how the Walker performs in your conditions.

A handwritten signature in black ink that reads "Bob Walker".

Bob Walker, Chairman
Walker Manufacturing





Backyard Therapy

Zeke Rhodes makes his living designing plumbing and HVAC systems, but the real living starts when he's outside on his Walker Mower.

"If you're ever going to have a stroke, I guess the best time to do it is before you're born." Those are the profound and very personal words of Zeke Rhodes, a 35-year-old husband, father and lawn care enthusiast. That is exactly what happened to Zeke, leaving him without any fine motor skills on his right side. But since he was born that way, Zeke never knew anything different and didn't have to relearn anything. It was just the way things were. In a way, Zeke says, that gave him an advantage.

Even after retiring from his landscaping business, Zeke Rhodes still loves mowing his family lawn in Newton, Utah.



Zeke Rhodes loves his backyard full of “toys”. From left, Zeke Rhodes, Randy Rigby, and Zeke’s dad, Kevin Rhodes. Zeke’s Walker fleet also includes a fourth mower not pictured here.

Born and raised in the small northern Utah town of Newton, Zeke loved mowing lawns from the time he could barely reach the handlebars on a push mower. When Zeke was nine years old, a gentleman named Randy Rigby moved to town and started a landscaping company. “Randy became my idol growing up,” Zeke says.

Randy and his wife got to know Zeke’s parents, Kevin and Teri, through church.

“I’ll never forget what Randy said to me after showing me around,” Zeke recalls. “Randy said, ‘You know, I think I’m going to put you on this yellow one.’ He set up some cones in his yard and let me drive the Walker around a while. I did my best and have been hooked ever since.”

Zeke must have done pretty well because Randy hired him. Zeke credits the easy controls of the Walker Mower

Part Determination, Part Captivation

“Zeke meant everything to my business,” Randy says. “Zeke never backed down from anything and did everything anybody else would do. When he got his driver’s license, Zeke even drove one of my trucks and went off and mowed on his own.”

“Yeah, I’d pretty much do anything

“...all of my friends were buying dirt bikes and things like that, but I was saving up my money to buy my own Walker.”

“My wife thought Zeke was adorable and wanted to adopt him,” Randy says with a smile. Zeke’s parents had a better idea. “They said I should apply for a job with Randy,” Zeke says. “So that’s what I did.

After a casual job interview, Randy led Zeke outside to check out some of the landscaping equipment.

for his short learning curve. “With my right arm the way it is, pushing those big levers forward on a typical zero-turn mower can be hard,” Zeke relates. “There’s just something about a Walker. It’s just easy, and that makes it fun to run.”

While Zeke credits the Walker itself for his operating skills, Randy credits something else: Zeke’s character.

Randy asked me ... except ride the Dixon,” Zeke says while bursting into laughter. He’s talking about the once famous blue zero-turn mower that has since faded into the history books. But “the yellow one,” as Randy once referred to the Walker, continues to be a big part of Zeke’s life today.

“When I was a kid working for Randy, all of my friends were buying dirt bikes

and things like that," Zeke remembers. "But I was saving up my money to buy my own Walker." A year or two later, an opportunity presented itself.

Randy told Zeke's dad about a used Walker he saw for sale down in Salt Lake City, about 1.5 hours south of Newton. "It was in a price range I could afford, so that's when I bought my first Walker," Zeke tells.

Rhodes ended up working for Randy for five years, and then another two for the person Randy sold his business to. Once he became the proud owner of his own Walker Mower, Zeke also started a business of his own on the side, a business he sustained while going to college.

A Passion for Mowing

Today, Zeke makes his living designing plumbing and HVAC systems. It's a far cry from what he went to college for, but he enjoys it. He also continues to enjoy his Walker Mower. In fact, he has four of them, along with several attachments. The aerator, dethatcher and one mower stay at Zeke's parents' house in Newton. The other mowers, along with the sprayer and snowblower attachments, are up at Zeke's place in Preston, Idaho, about a half-hour to the north.

"Along with my parents' lawn, I still aerate and dethatch a few lawns in

Newton," Zeke says, adding that he could never completely give up his passion. "But I more or less had to get out of the lawn business once my career got going. With the way the building market has been around here, my job has been just insane. But I still love my toys. It's not just cutting grass to me. Getting out in my own yard with my Walker is therapy."

Zeke's mom, Teri, feels the same way. The yardwork duties are very defined at her house. She handles the mowing with the Walker, a machine she is just as captivated with as Zeke is. Zeke's dad, Kevin, is on weed patrol. Teri admits that she has the better end of that deal. She also admits that she is nearly as fanatical about her stripes and patterns as her son. "I told Zeke that we might as well just sell this place if he ever decides to take his mowers back up to Idaho with him," Teri says.

Lawn Pride

It is pretty remarkable, really. On the day Walker Talk visited, the editor grew a bit concerned as he made his final turn onto the road leading to the Rhodes family home in Newton. House after house didn't have much lawn to speak of, thanks to the area's arid mountain climate. But when the GPS voice said, "You've arrived," it was like being transplanted to a completely different environment. The front yard is well-landscaped



Zeke's parents have some cattle to go along with their lush backyard. When Zeke pulls into the pen area with a hopper full of grass clippings, the hungry cows know it's snack time.

with mulch, defined beds, and healthy trees and shrubs. The lawn in the back is irrigated, fertilized and treated for pests and weeds.

"Lawn pride" is definitely something that runs deep in the Rhodes family. Back up in Preston, Idaho, Zeke's two young boys, 10-year-old Jackson and 5-year-old Brody, are already obsessed about learning to run the Walker.

"Now that my sons are getting a little older and need something to do, maybe I'll find a few customers up here so they can eventually get a stake in the game, too," Zeke says. After all, Zeke Rhodes started mowing with a Walker as a young man. "If there has been a theme in my life, it's Walker," Zeke says.



Randy Rigby put Zeke on "the yellow one" when he was just 12 years old. Now at 35, Zeke still won't mow with anything else.

See Zeke's story by watching this video.



SCAN ME

Walker Advantages

Front-Mount Deck

Achieving a beautiful cut has been our focus from the very first Walker Mower design. Positioning the mowing deck in front of the machine is fundamental to producing high-quality results. The front-mount deck of the Walker reduces impact on the turf prior to cutting, resulting in a more consistent, carpet-like finish. This result is achieved by transferring weight from the deck caster tires which minimizes matting of the grass.

The Walker's flexible deck suspension provides smooth, consistent cutting as the front mounted deck articulates independently of the tractor following ground contour, minimizing scalping, and providing a beautiful cut.

The Walker torsion-flex carrier frame allows the deck to freely articulate and flex laterally, producing a smooth cut, even over complicated ground contours. This makes Walker Mowers ideal for mowing uneven turf.

Short Deck Coupling

Front-mount decks also create a shorter distance between the contact point of the drive tire and the contact point of the front caster tire, allowing Walker decks to precisely follow ground contours. Compared to mid-mount hanging decks used on other mowers, Walker mowing decks scalp less and leave less uncut grass in the valleys of ground contours.

Scalp less grass on the crest



Cut more grass in the valley





Switch a deck



For an add-on

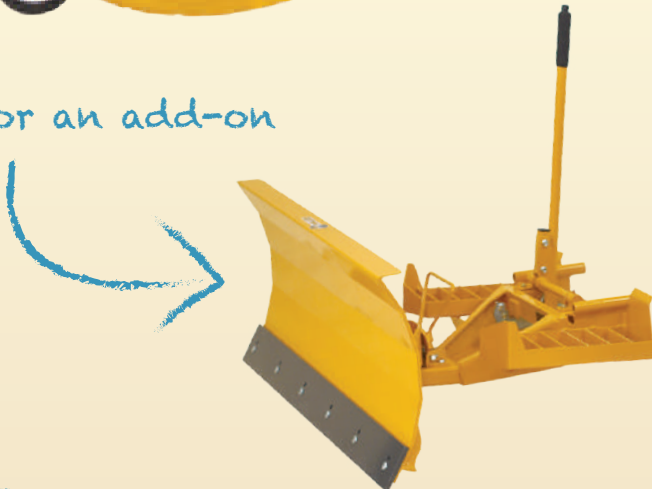

Easy access to engine and drivetrain



Interchangeable Decks and Add-ons

Whether handling grass, leaves, debris, or snow, Walker Mowers are designed for year-round productivity. On most models, decks can easily be switched for larger or smaller collection, mulching, or discharge decks to suit the task at hand. Plus with dozens of add-ons, such as a dethatcher, dozer blades, snowblowers, and enclosed cabs, the Walker is one of the most versatile mowers on the market.

Tilt-Open Bodies and Tilt-Up Decks

Each Walker features a tilt-open body, quickly exposing the drive belts, electrical system, engine, and drivetrain, making service and maintenance easy. No special tools or equipment are needed. Simply release the body latch, and the gas spring assisted enclosure opens up for unobstructed access to all of the Walker's working components.

All Walker decks quickly tilt-up, making maintenance tasks safe and easy. It takes seconds to unlock, lift, and secure the deck in an up position, providing access to the blades, housing, and chute. H models also have an optional Power Tilt-Up® deck lift. Walker tilt-up decks also minimize wasted space when storing the Walker Mower.

Easy and safe access for deck cleaning and blade maintenance



Walker Advantages

Grass Handling System® (GHS)

Walker invented the internal Grass Handling System® on its first mower, and it remains the most efficient way to vacuum grass clippings, leaves, and debris from the lawn.

Collection decks move clippings to a center, rear discharge chute where an internal blower vacuums grass clippings and debris, and then blows it directly into a compact, rear-mounted grass catcher box. The PowerFil® oscillating chute evenly packs clippings, and the Grass-Pak® full signal alerts the operator when it is time to empty the catcher. To dump clippings, the operator simply lifts the catcher with the side handles, or utilizes the optional Power Dump or Hi-Dump® add-ons from the operator seat.



Pictured: S18 with optional Power Dump

Integrated Components

Walker Mowers are engineered to ensure the entire grass collection system is internal. This intentional effort has allowed Walker Mowers to retain their compact footprint. There are no bulky tubes or bags extending beyond the footprint of the mower. By positioning the GHS blower internally, a powerful vacuum action is achieved, leaving a carpet-like appearance to your lawn in spring, summer, and fall.

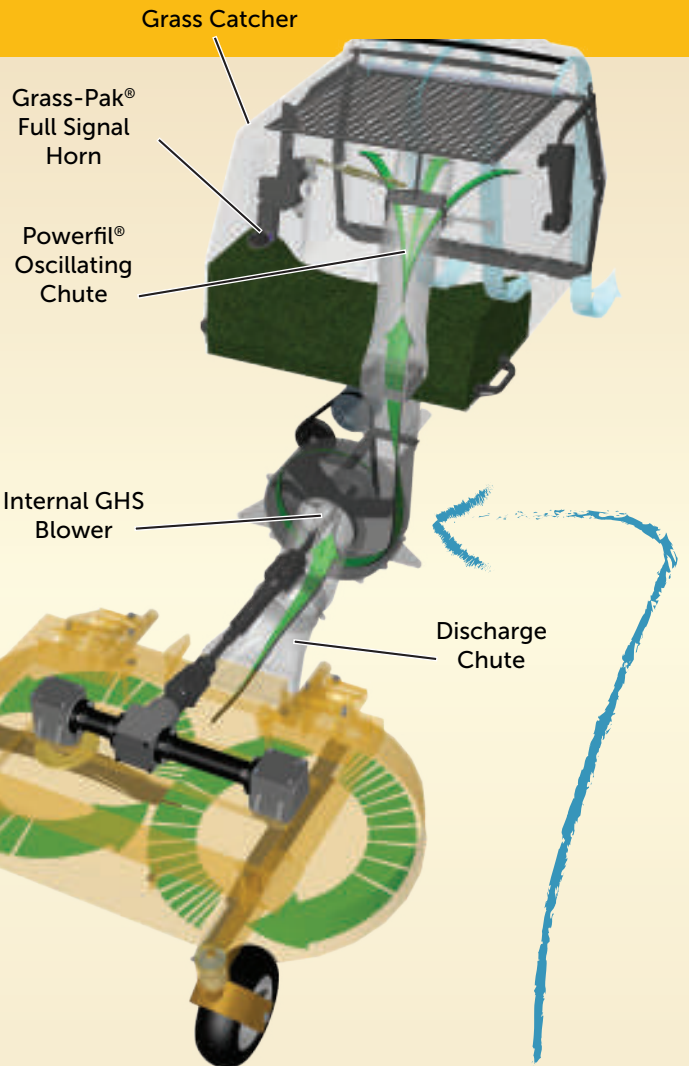

Blowers create a vacuum

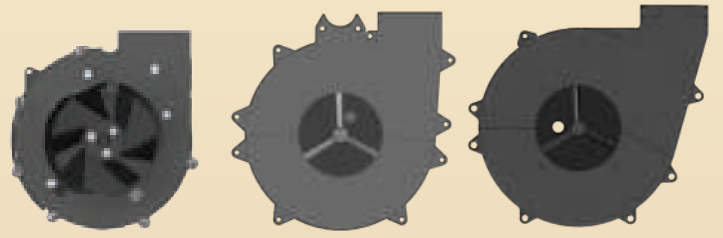

Internal GHS 10.5" (26.67 cm) Blower (Models C19, C19i, T, D)

Internal GHS 12.75" (32.38 cm) Blower (Model S)

Internal GHS 13.25" (33.66 cm) Blower (Models C23i)



Precision Steering and Handling

With an operator-friendly combination of finger-tip steering and the Forward Speed Control, the Walker Mower goes precisely where you want it to with little effort.

Forward Speed Control

Once in the drive position, the Forward Speed Control uses a friction lock to work as a cruise control, allowing you to control the mower by simply applying pulling pressure on the steering levers. To stop, pull the Forward Speed Control back to the Neutral-Park position.

Steering Levers

Walker Mower steering levers take control the moment pressure is applied. Each steering lever is spring-dampened, providing smooth machine operation. You can easily steer the machine by controlling both levers with a single hand, only using gentle fingertip pressure. The steering system is designed for precision steering and handling, using optimal linkage geometry and high-quality components.

Compact

Most lawns have areas with low hanging branches, narrow gates, or other obstacles that are difficult to mow. The compact size of the Walker Mower gives you the ability to mow challenging properties easily and efficiently.

The Walker Mower has a small footprint designed to get into and out of tight places like gates, between beds and trees, fence corners, and other similar landscape features.



Walker T27i with 52" deck footprint:
53" (134.62 cm) W 95" (241.30 cm) L
Versus a Z Master with 52" deck footprint:
68" (172.72 cm) W 102" (259.08 cm) L



Walker Advantages



Transmission Oil Performance System (TOPS)[™]

TOPS[™] brings enhanced drivetrain protection and performance to all Walker Mowers equipped with Eaton Model 7 hydrostatic transmissions by actively circulating and filtering the transmission system fluid every 38 seconds.

TOPS[™] includes:

- A fully-machined, billet aluminum oil pump with integrated filter mount is driven by transmission drive belt and circulates filtered oil when engine is running
- An oil filter with premium fiberglass media made in the USA for Walker
- Remote aluminum oil reservoir increases oil capacity by 100% and reduces oil temperature
- Fully-synthetic oil formulated specifically for extended transmission life under high loads and in extreme ambient temperatures
- ISO-VG 220 viscosity oil for superior protection and performance
- A maintenance schedule that adds 500-hour oil and filter change interval after the initial 100-hour break-in service
- Extended transmission warranty when serviced as directed, conditions apply

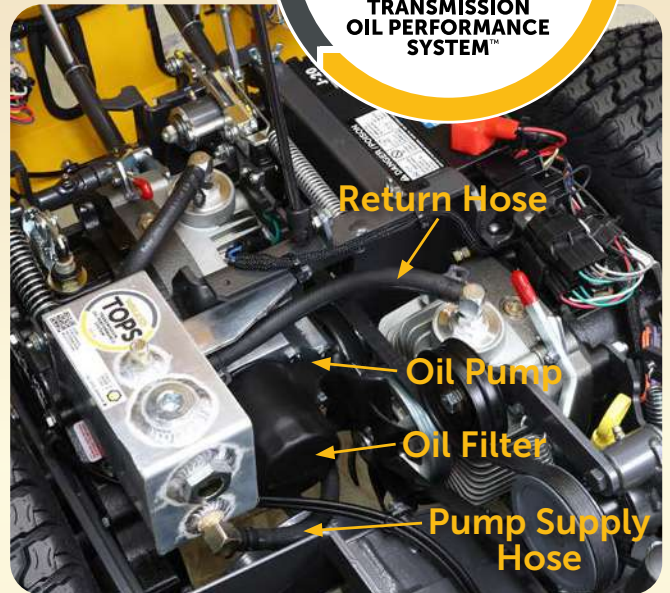

TOPS[™] =
Longer Transmission Life
AND
Extended Transmission
Warranty



See more details at:
walker.com/tops



TOPS[™] OIL
Mobil SHC[™]
630

TOPS[™] Oil
Filter



3X longer oil change interval



Standard oil and filter in Kohler engines from Walker

Kohler PRO 300-Hour Extended Life Engine Oil and Filter

Kohler PRO 300-hour, extended-life synthetic oil and filter provides unmatched protection for Walker Mowers equipped with Kohler engines. This 10W-50 fully-synthetic oil has a 3x longer life, extending oil changes while providing ideal engine protection in all seasons and all temperatures.

- 3X longer oil change interval
- Engineered by Amsoil exclusively for Kohler
- Fully-synthetic oil formulated specifically for extended oil change intervals in Kohler air-cooled engines
- Guaranteed 300-hour oil change interval on most KOHLER® gas engines past, present, and future
- 10W-50 viscosity for all season performance
- Extra corrosion inhibitor for seasonal storage and multi-season use
- Lower oil consumption than conventional oil
- Warranty approved for KOHLER engines

See more details at:
walker.com/kohler-engine-oil

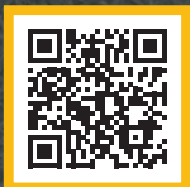

Kohler PRO Synthetic 10W-50 --vs-- Conventional Auto Engine Oil (API-SN)

	Kohler PRO Synthetic 10W-50	Conv. Auto Oil (API-SN)
Guaranteed 300-hour oil change interval	✓	✗
Extra corrosion protection for seasonal storage	✓	✗
Multi-season operation	✓	✗
Superior performance for extreme cold and hot operation temperatures	✓	✗
Lower oil consumption	✓	✗



Alex Cembalisky of Bay View Turf Specialists, mows the private home of one of his clients in Marion, Massachusetts.



A Love for the Science of Growing Gorgeous Grass

Alex Cembalisty says he was never an A or B student in high school. "I just wanted to put on my boots and go have fun in the dirt," he says. "I developed this passion for trees, plants and grass. I guess you can say I've always had a green thumb."

Today, Alex is the owner of Bay View Turf Specialists in Dighton, Massachusetts. The company provides lawn care and maintenance services for a broad spectrum of clients throughout southern Massachusetts.

Alex first started mowing lawns in 2010 on a part-time basis. His initial customers were family and friends. Soon he began adding some of their neighbors to his route. Alex's passion for lawn care grew right along with his customer base. So did his desire to learn more about it.

"It's a funny story," Alex tells. "One day my mom said to me, 'You know, you can go to school for this.' I said, 'School for what?' My mom said, 'Grass. You can actually go to school to learn about grass.'"

Cembalisty did a little research and discovered The Stockbridge School of Agriculture at the University of Massachusetts Amherst. He applied for the turf science program. "I didn't get in at first and I was heartbroken," Alex says. But he persevered and knocked on the door again. He was accepted in 2011.

"I'm not sure what I value most from my experience in college, the education or the folks I met," Alex says. "I

met so many great people who became my mentors. If you can surround yourself with people who've done the same thing, and you put in the hard work, the world is yours."

After graduating college, Alex's professional world consisted of selling fertilizer for a Florida-based manufacturer. He enjoyed it, but didn't feel the same passion he did when working on lawns.

"I still had my lawn care business on the side," he points out. "When you have this thing on the side that just won't seem to go away, that's a sign. I needed to focus on my lawn business because that's what I really wanted to do."

Alex's short career selling fertilizer is also what connected him to Will Humberstone, one of his two valued employees. He gave a presentation to students of the same turf science program he had graduated from. Will was one of those students.

The other employee, Mac Monteiro, happens to be Alex's uncle. Mac is a retired truck driver who grew tired of sitting around the house. Now Mac sits on a Walker Mower every day. "Mac's favorite word is, 'OK,'" Alex says with a smile. "Mac loves working outside and will do just about anything."

As a lawn care company, Bay View Turf Specialists will do just about anything, too, at least to a certain degree.

Finding the Right Mix

On the day Walker Talk visited, Alex and Will harmoniously trumpeted the fact that standards matter most to Bay View Turf Specialists. When a lawn care company remains in relentless pursuit of a higher standard, everything else can fall into place. The full-service lawn care company provides mowing and maintenance, fertilizing, and weed, insect and disease applications for both turf and ornamentals. Clients range from lower-end residential properties

to estates, commercial accounts and even some athletic fields.

"We touch a lot of bases and the quality standard is attempted to be matched across the board," Will points out. "Even on a lower-end residential property that isn't treated, we can go in there and make it look pretty darn good with our mowing and edging," Alex adds. "That's where our three Walker Mowers come into play."



The Bay View Turf Specialists team, from left: Mac Monteiro, owner Alex Cembalisty, and Will Humberstone.

Bay View Turf Specialists' professionalism is also held to a high standard across the board. Alex says his commitment to professionalism is one of the things that drew Will to his company. Both Alex and Will have golf course backgrounds. They strive to bring that same polished image to lawn care contracting, right down to the khaki pants and polo shirts they wear while servicing properties.

When a lawn care company remains in relentless pursuit of a higher standard, everything else can fall into place.

Versatility is another key principle of Alex's business philosophy. Having a good mix of clients and services not only diminishes business risk, but also helps keep him fresh and

upbeat. The Bay View Turf Specialists crew typically schedules applications Monday through Wednesday, and then switches over to mowing for the remainder of the week.

"I don't see how somebody can do nothing but applications all day, or do nothing but mow every single day," Alex relates. "For some people, I'm sure that is just fine. But for me, it's good to be mixed. A good mix keeps you good."

Speaking of mixes, Alex and Will leverage their turf science education to come up with some unique lawn care applications.

"There is a lot more to the game than NPK," Alex says in reference to the popular lawn fertilizer formula of nitrogen, phosphorous and potassium. "Think about how many nutrients there are that plants and

grass need. Boron. Copper. Nickel. Magnesium. Manganese. When has a lawn care professional shown up to spray a cocktail on your lawn? When you start using these different

products, you can see the difference. Plants want that.”

As Alex and Will each learned in college, lawn care truly is a science. The same can be said about mowing and maintenance.

There is a Science to Beautiful Mowing, Too

“Every time we step onto a property, Will and I talk about what we want to do that day,” Alex says. “Should we mow to 3-1/2 inches, or maybe bump it up to 4? When did we put a treatment on? How hot is it going to get over the next week? We don’t want that lawn to get stressed. Proper mowing and maintenance is a key part of the value we bring to clients. There is even a bit of a science to good edging and string trimming.

“To make that happen, I want the best,” Alex continues. “I want the best equipment, the nicest truck and best people. I want to be surrounded by the best. The Walker Mower brings that all to the table.”

Bay View Turf Specialists has three Walker Mowers, all 48-inch GHS models. Alex’s earlier purchases were Model C’s geared toward residential properties. He has since stepped up to the Model T for the extra grass-handling capacity. Alex can’t imagine himself, Will or Mac mowing with anything else. Will agrees.

“With my golf course background, I’ve mowed with everything from



Alex Cembalistry leverages his turf science degree to come up with some unique “chemical cocktails” to feed lawns and plants with the nutrients they need to flourish.

stand-ons to big greens mowers,” Will relates. “The speed of the machine says it all, and nothing quite compares to the cut of the Walker. You can get into tough areas with a pristine quality of cut that leaves the turf in a really good standing. You can walk on a lawn after you mow and see how clean those blades of grass are. They aren’t all chewed up. They are healthy, and that’s what we want.”

Setting a High Bar Sets the Table for Growth

Alex Cembalistry is happy he went to college for turf science. He is happy he left his job as a fertilizer salesman to focus on his lawn care company. Most of all, he is happy with where his company is at.

“We could probably be bigger,” Alex

says. “But if you grow it, you have to feed it. We want to stay focused on maintaining that standard we have set. But that doesn’t mean we aren’t growing in other ways. You always have to keep learning and striving to get better. That’s how we keep bringing value to our customers.”

Alex also brings value to his lawn care customers by taking winters off. He has attempted both tree care and snow removal. No thank you. “I can’t stand those long New England winters,” Alex says. Come spring, it’s back to Massachusetts to start doing lawn care again.

“When you love what you do, you’ll never be lazy,” Alex says. “I love this. We’ll finish up a long day of mowing and I’ll tell my guys that I’m going home to mow my own lawn. Mac says, ‘Are you crazy?’ But I love it. I’m going home to sit on my lawn mower, a beautiful Walker, to mow nice stripes so it looks like a million bucks. I just fertilized a couple days ago. Perfect.”



Will has operated everything from stand-on mowers to large greens mowers. He says nothing compares to the agility and cut of a Walker.



See Alex’s story by watching this video.

SCAN ME

Model S

The Model S is the quintessential Walker Mower. Inspired by the original 1977 prototype, the Model S is simple and easy to operate and very efficient at mowing residential properties. With Walker's Grass Handling System®, a patented Blower Shaft PTO® design, and reduced weight and cost, the Model S is the perfect entry-level mower for experiencing Walker's signature beautiful cut and zero-turn productivity.

Entry-level collection mower, ideal for smaller properties



Model S18

- 18 HP Briggs and Stratton Vanguard engine
- Commercial rated compact V-Twin with pressure oil lubrication
- 7.4 MPH (11.9 km/h) ground speed
- 4 gallon (15.1 liter) fuel tank
- Deck/Kit options: Collection 36"-48" (91 cm-122 cm), Mulching 36"-48" (91 cm-122 cm), Discharge 36"-56" (91 cm-142 cm)



Dethatcher



36" Snowblower



Pictured: S18 with a 48" (122 cm) collection deck.

Model S Standard Features

- Precision Steering and Handling
- Forward Speed Control
- Grass Handling System® (GHS)
- 7 bushel (8.7 cu. ft.) grass catcher
- High capacity, commercial engine air filtration
- Hydro-Gear ZT3100 transmissions
- Tilt-up decks and tilt-open body
- Flexible deck-carrier frame
- 12.75" (32.38 cm) Thru-Shaft® PTO GHS blower
- Oscillating PowerFil® chute with Grass-Pak® full signal

Model S Popular Add-ons

- Power Dump
- LED Headlights
- Adjustable Footrests
- Dethatcher
- 48" (122 cm) Dozer Blade
- 36" (92 cm) Single-Stage Snowblower
- Spyker® Spreader and Mount
- Comfort Seat with optional Armrests

See more details at:
[walkermowers.co.nz/
model/ms18](http://walkermowers.co.nz/model/ms18)

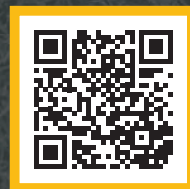

Model C

The Model C is the original Walker commercial lawn mower. Since its introduction in 1986, the Model C has been continually refined and improved with the commercial operator in mind, especially those who maintain residential properties. The Model C is a compact and versatile mower with impressive productivity.

Commercial collection
mower that can run
powerful add-ons



Model C19

- 19 HP Kohler Command Pro CH620 engine
- 10.0 bushel (12.4 cu. ft.) grass catcher option
- Eaton Model 7 transmissions with ductile cast iron gearbox final drives
- Transmission Oil Performance System (TOPS)[™]
- Deck/Kit options: Collection 36"-48" (91 cm-122 cm), Mulching 36"-52" (91 cm-132 cm), Discharge 36"-60" (91 cm-152 cm)

Model C19i

- 19 HP Kohler Command Pro ECH630 EFI engine
- Superior fuel efficiency, startability, and performance
- Eaton Model 7 transmissions with ductile cast iron gearbox final drives
- Transmission Oil Performance System (TOPS)[™]
- Deck/Kit options: Collection 36"-52" (91 cm-132 cm), Mulching 36"-52" (91 cm-132 cm), Discharge 36"-60" (91 cm-152 cm)

Model C23i

New 2023 Model!

- 23 HP Kohler Command Pro ECH630 EFI engine
- 10.0 bushel (12.4 cu. ft.) grass catcher option
- Deck/Kit options: Collection 42"-52" (107 cm-132 cm), Mulching 42"-52" (107 cm-132 cm), Discharge 42"-60" (107 cm-152 cm)

Model C Standard Features

- Precision Steering and Handling
- Forward Speed Control
- Grass Handling System[®] (GHS)
- 7 bushel (8.7 cu. ft.) grass catcher
- 4 gallon (15.1 liter) fuel tank
- Kohler PRO 300-Hour Extended Life Oil and Filter
- Well balanced for superior hillside stability

Model C Popular Add-ons

- LED Headlights
- Dethatcher
- Operator Soft Cab (C19, C19i)
- Implement Hitch with electric ram lift (C19, C19i)
- 42" (107 cm) Two-Stage Snowblower
- Comfort Seat
- Power Dump (C19, C19i)
- 48" (122 cm) Dozer Blade



Comfort Seat

See more details at:
www.walkermowers.co.nz/models/collection



Pictured: C19i with a 42" (107 cm) collection deck.

Model T

The Model T is the standard for what commercial operators expect from a lawn mower. Intended specifically for commercial use, every aspect of the Model T has been designed to meet the most demanding expectations of operators who want fast and easy mowing with beautiful results. It is the go-to Walker for commercial operations and a favorite among discerning customers.



The go-to collection mower for power and versatility

Model T23

- 23 HP Kohler Command Pro CH680 engine
- Commercial mower with carbureted engine
- Comfort Seat with optional Armrests
- Non-collection version is available
- Deck/Kit options: Collection 36"-52" (91 cm-132 cm), Mulching 36"-52" (91 cm-132 cm), Discharge 36"-74" (91 cm-188 cm)

Model T27i

- 26.5 HP Kohler Command Pro ECH749 EFI engine
- Superior fuel efficiency
- Comfort Seat with optional Armrests
- Non-collection version is available
- Deck/Kit options: Collection 36"-52" (91 cm-132 cm), Mulching 36"-52" (91 cm-132 cm), Discharge 36"-74" (91 cm-188 cm)



Hi-Dump®



Pictured: T23 with a 48" (122 cm) collection deck.

Model T Standard Features

- Precision Steering and Handling
- Forward Speed Control
- Grass Handling System® (GHS)
- 10 bushel (12.4 cu. ft.) grass catcher
- Commercial air filter with remote air intake and turbine pre-cleaner
- Eaton Model 7 transmissions with ductile cast iron gearbox final drives
- Flexible deck-carrier frame
- Tilt-up deck and tilt-open body
- 4.7 gallon (17.8 liter) fuel tank
- 10.5" (27 cm) GHS blower
- Transmission Oil Performance System (TOPS)™
- Kohler PRO 300-Hour Extended Life Oil and Filter

Model T Popular Add-ons

- Hi-Dump® grass catcher system raises 67" (171 cm) with automatic catcher door actuation
- Power Dump
- LED Headlights
- Dethatcher
- Implement Hitch with electric ram lift
- 42" (107 cm) Two-Stage Snowblower
- 48" (122 cm) Dozer Blade
- Spyker® Spreader and Mount

See more details at:
www.walkermowers.co.nz/models/collection



Model *D*

The Model D is an industrial-grade Walker Mower with impressive power and agility. The Model D is the only diesel-powered Walker Mower equipped with the Walker Grass Handling System® (GHS). The Model D effortlessly handles the harshest mowing environments and extended running times without compromising efficiency or power.



Diesel-powered,
versatile, commercial
collection mower

Model *D*21d

- 20.9 HP three cylinder Kubota D722 diesel engine
- 10 bushel (12.4 cu. ft.) grass catcher
- Deck/Kit options: Collection 36"-52" (91 cm-132 cm), Mulching 36"-52" (91 cm-132 cm), Discharge 36"-74" (91 cm-188 cm)



Operator Soft Cab and
42" Snowblower

See more details at:
www.walkermowers.co.nz/model/md21d



Model D Standard Features

- Precision Steering and Handling
- Forward Speed Control
- Grass Handling System® (GHS)
- Automatic glow plug preheat
- Transverse engine mount
- Liquid-cooled with self-cleaning radiator
- Impressive 34 ft-lb torque
- High-capacity, commercial air filter with remote air intake and turbine pre-cleaner
- Eaton Model 7 transmissions with ductile cast iron gearbox final drives
- Grammer four-way adjustable Suspension Seat
- Tilt-up deck and tilt-open body
- Flexible deck-carrier frame
- High output 40-amp charging system
- 10.5" (27 cm) GHS blower
- Oscillating PowerFil® chute with Grass-Pak® full signal
- Transmission Oil Performance System (TOPS)™

Model D Popular Add-ons

- Hi-Dump® grass catcher system raises 67" (171 cm) with automatic catcher door actuation
- Power Dump
- LED Headlights
- Dethatcher
- Operator Soft Cab
- Implement Hitch with electric ram lift
- 42" (107 cm) Two-Stage Snowblower
- 48" (122 cm) Dozer Blade



Pictured: D21d with a 52" (132 cm) collection deck.

Model *R*

The Model R is the perfect Walker Mower for residential properties. The belt-driven mower blades make operation smooth and quiet without compromising on the Walker Mower's distinct advantages.

The Model R provides a premium Walker experience so you can bring home fast, easy, beautiful mowing.

Lowest price, non-collection
Walker mower, designed
specifically for residential owners



Model R21

- 42" (107 cm), 48" (122 cm), or 54" (137 cm) discharge deck cutting width configurations
- Belt-driven blades with dampened belt tensioner for smooth, quiet operation
- Custom blade spindles with grease zerk and bleed valve
- Molded rubber side discharge deflector shield



Accelerator® grass catcher



Dozer Blade, new for 2023!

3 YEAR
300 HRS

The Model R features a three-year, 300-hour, caster-to-caster residential warranty. All parts and components are covered against manufacturer's defect.



Pictured: R21 with a 48" (122 cm) side discharge deck.

Model R Standard Features

- Precision Steering and Handling
- Forward Speed Control
- 21 HP Kohler KT620 with Smart-Choke® technology for easy starts in hot and cold weather
- Hydro-Gear EZT transmissions
- Ogura® electric blade clutch and brake with easy pull/push switch operation
- Tilt-up deck and tilt-open seat
- 3 gallon (11.4 liter) custom molded, low profile fuel tank with integrated fuel level gauge
- Flexible deck-carrier frame
- Two drive belts with spring-loaded tensioning idler pulleys: ground drive and blade drive
- Kohler PRO 300-Hour Extended Life Oil and Filter

Model R Popular Add-ons

- Comfort Seat
- Tow Hitch
- Mulching Kit including bolt-in baffles and serrated mulching blades
- Accelerator® 3.3 bushel (4.2 cu. ft.) side-mount grass catcher
- LED Light Kit
- A44 Dozer Blade

Mulching Option

See more details at:

www.walkermowers.co.nz/model/mr21

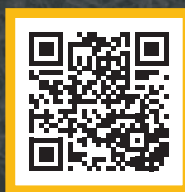

Model *B*

The Model B is compact and fast. It is a Walker Mower designed to run side discharge and mulch decks on difficult properties with hills, uneven terrain, and obstacles, all while leaving a beautiful cut. The Model B is configurable and versatile to meet a professional's expectations.

Discharge or mulch, lightweight, responsive, and great on hills



Model *B23*

- 22.5 HP Kohler Command Pro CH680 engine
- Commercial mower with carbureted engine
- Integrated Ogura® electric clutch with Soft Start
- Comfort Seat with optional Armrests
- 4.7 gallon (17.8 liter) fuel tank
- Deck/Kit options: Mulching 36"-52" (91 cm-132 cm), Discharge 36"-74" (91 cm-188 cm)

Model *B27i*

- 26.5 HP Kohler Command Pro ECH749 EFI engine
- Superior fuel efficiency and economy
- Integrated Ogura® electric clutch with Soft Start
- Comfort Seat with optional Armrests
- 4.7 gallon (17.8 liter) fuel tank
- Deck/Kit options: Mulching 36"-52" (91 cm-132 cm), Discharge 36"-74" (91 cm-188 cm)

See more details at:
www.walkermowers.co.nz/models/non-collection



*Pictured: B27i with a 48" (122 cm) mulching deck.
Shown with optional utility bed and optional suspension seat.*

Model B Standard Features

- Precision Steering and Handling
- Forward Speed Control
- High-capacity, commercial engine air filtration
- Hydro-Gear ZT3100 transmissions
- 8 MPH (13 km/h) maximum ground speed
- Flexible deck-carrier frame
- Tilt-up deck and tilt-open body
- Kohler PRO 300-Hour Extended Life Oil and Filter

Model B Popular Add-ons

- Utility Bed
- 36" (92 cm) Single-Stage Snowblower
- Spyker® Spreader and Mount
- 48" (122 cm) Dozer Blade
- LED Headlights
- Suspension Seat
- Big Tire Kit
- Tow Hitch
- Dethatcher
- Implement Hitch
- Loader Bucket
- Accelerator® 3.3 bushel (4.2 cu. ft.) side-mount grass catcher



Spyker® Spreader

Model *H*

The Walker Model H stands alone in its class for high production mowing and improved return on investment. When fast, beautiful results are demanded on vastly different properties, turf types, and conditions, the Model H delivers for the most discerning operators. A variety of attachments and add-ons keep the Model H productive year-round with excellent results.

High production, versatile discharge or mulch, commercial mower



Model *H*24d

- 23.7 HP Kohler KDW1003 diesel engine
- Rubber isolation engine mounts
- Liquid cooled with self-cleaning radiator
- Standard ROPS and Utility Bed

Model *H*27i

- 26.5 HP Kohler Command Pro ECH749 EFI engine
- Kohler PRO 300-Hour Extended Life Oil and Filter
- Superior fuel efficiency
- Lightest weight Model H, minimizing turf damage

Model *H*37i

- 37 HP Briggs and Stratton Vanguard Delphi fuel injected engine
- Superior fuel efficiency
- High output 50-amp charging system

Model *H*38i

- 38 HP Kohler Command Pro ECH980 EFI engine
- Increased displacement and torque
- Cyclonic high-capacity air filter

Model H Standard Features

- Precision Steering and Handling
- Forward Speed Control
- Grammer 4-way adjustable Suspension Seat
- High capacity, commercial engine air filtration
- Hydro-Gear ZT3400 transmissions
- 3 Model H-specific mowing decks with integrated Deck Height Adjuster and Adjustable Foot Rest
- Flexible deck-carrier frame
- Tilt-up deck and tilt-open body
- 9.4 gallon (35.6 liter) fuel capacity, dual tanks
- Deck/Kit options: Mulching 48"-61" (122 cm-155 cm), Discharge 48"-74" (122 cm-188 cm)

Model H Popular Add-ons

- Power Tilt-Up® deck lift
- LED Headlights
- Deck arm adapter kit, allowing compatibility with six additional Walker mowing decks
- Implement Hitch with electric ram lift
- Operator Hard Cab
- 50" (127 cm) Two-Stage Snowblower
- 60" (152 cm) Rotary Broom
- 60" (152 cm) Dozer Blade

See more details at:
www.walkermowers.co.nz/models/non-collection

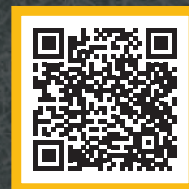

Pictured: H37i (left, middle) and H24d (right) both with a 64" (163 cm) rear discharge deck.

Walker-Friendly and Almost Stress-Free

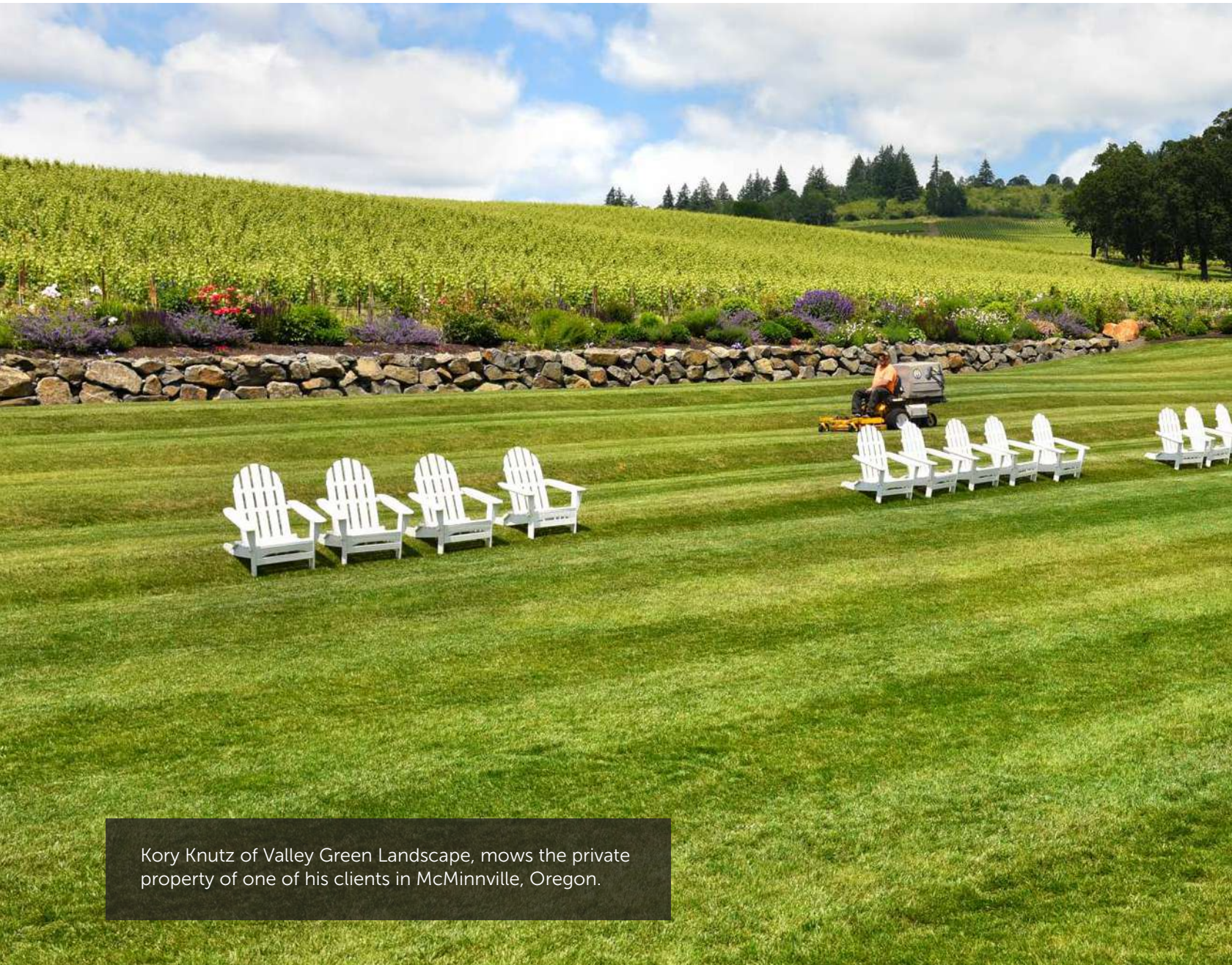

Kory Knutz of Valley Green Landscape, mows the private property of one of his clients in McMinnville, Oregon.

Kory Knutz loves landscape maintenance. "I don't have any desire for installation work," he relates. "In fact, that's even on my voicemail greeting. Maintenance is where it's at for me. Maintenance is my sweet spot."

It wasn't always that way for the owner of Valley Green Landscape in McMinnville, Oregon. After going full-time with his mowing business in 1995, Kory resisted customer requests to provide installation services for 10 years. Then the building market exploded and Kory was lured in. But then the building bubble burst in 2008 and he got right back out.

"Fortunately, I was able to survive after liquidating some skid steers, dump trucks, and other equipment," he says. "I did like doing designs and really enjoyed planting. But it was just too many employees, too much equipment, and too much administrative work. I thought I was going to die by the time I was 50. I knew I wasn't doing something right because I just wasn't enjoying it. I've always enjoyed maintenance, though, and I can honestly say that I enjoy it more every year."

Kory has been enjoying maintenance for 33 years now, dating back to when he first started "mowing grandma lawns" at age 12.



Now in his mid-40s, Kory still mows some of those original grandma lawns, along with a bunch of other residential accounts, banks, industrial parks, and a prestigious vineyard that keeps his entire crew busy one day a week.

Doing What You're Good At

Knutz got his first Walker Mower in 1995, not long after he'd graduated high school and went full-time in business. "The Walker first came to my attention when I saw other lawns that were mowed with a Walker," he recalls. "I wondered what in the world they were mowing with because it didn't look anything like what I was using. So I got my first Walker and then got another one a year later."



Kory Knutz and two of his faithful sidekicks: his dog, Wally, and his Walker Model H.

Kory says his business was revolutionized from an efficiency standpoint, enabling him to quickly add more accounts. That gave him the confidence to begin evaluating his account base "with a fine-tooth comb" to identify where he was and wasn't making money. He wanted to focus on those properties that were "Walker-friendly" so he could achieve both the quality

and efficiency needed to build a reputable business.

"I just don't feel like I have to be the 'do anything' guy anymore," Kory continues. "I have found that it makes more sense to find out what you're really good at, do it a lot and keep getting better at it. You can make a lot more money that way. I've also found that you'll be a lot happier."

Another key to staying happy and making good money is making good use of his Walkers. Kory tries to keep the 21-inch push mowing to a minimum.

"Using a push mower is like picking up nickels while you have piles of quarters sitting on your trailer," Kory relates. "I always want to capitalize on the potential of my Walkers. That's why I like to stick with properties that are Walker-friendly. I even helped one client widen a gate so one of my Walkers could fit through it."

Kory has 10 decks for his four Walker tractors. He bags the higher-profile

"I always want to capitalize on the potential of my Walkers. That's why I like to stick with properties that are Walker-friendly. I even helped one client widen a gate so one of my Walkers could fit through it."

lawns and side-discharges the rest. Kory has grown especially fond of the rear-discharge deck on his Model H. "Then you don't get dust and grass blowing up on top of you, and you don't have to worry about throwing grass in flower beds," he explains.

For Knutz, making good use of his Walkers means extending them beyond just mowing grass. The transportability and maneuverability of the machine make it an ideal option for blowing leaves, grading soil and plowing snow.

Kory has two snow blades that he says

are ideal for five-foot sidewalks. "They can really squeegee the snow off and are perfect for those six to eight inch snowstorms," Kory says. "In a good winter, I can pick up another \$5,000 to \$10,000 in snow removal revenue."

Kory is excited to see how a new attachment purchase will help him make more money this fall by helping save a lot of time. "My new Turbine Blower generates 10 times the CFM (cubic feet per minute) of the big backpack blower I've normally used to move leaves," he says.

To further extend the use of his Walker Mowers, Kory has even rigged up some handy attachments of his own.

"I strap a 25-gallon spray tank on the back of my Model H," Kory tells. "I can cover a lot more ground than walking around with a backpack sprayer. In fact, I can apply four more gallons per hour."

"To help with leaf pickup, I've made some hard-facing guards to further reinforce the steel side skirts on the deck," Kory continues. This

contraption gives Kory the confidence to run the mower on paved surfaces to suck up leaves in a parking lot, for instance. Another employee(s) blows the leaves into windrows that Kory vacuums up with the mower. "I cannot wait to see how this system works this fall with the new leaf blower attachment," Kory says. "We should be able to move a tremendous volume of leaves in a lot less time."

Finally, he has converted one of his older decks into a land planer. He uses it when doing lawn renovations. "The only thing as smooth as mowing with a Walker is grading with one," Kory says.

Nothing to Wine About These Days

Kory gets a lot of use out of his land planer and snow blades around his own property. It's a sprawling complex with steep ridges, a natural spring and pond, thousands of trees, and umpteen relaxation points with fire pits and paver patios. When Kory's sidekick, Wally, hears the engine on the Walker Mower rev up, he races to the start of the walking trail to lead Kory up the ridge to the spacious lawn area that needs to be mowed. Kory straps on his earmuffs, turns on the blades, and loses himself in the one thing he has loved doing since he was six years old. Wally takes a dip in the pond.

When Knutz isn't taking care of his own property, he and his trusted full-time employee, Gary Harper, are taking care of plenty of others. Along with being Walker-friendly, Kory prefers properties that are easily accessible with minimal drive time. He also likes it when he and Harper can be in and out in a relatively short amount of time.

One exception is the prestigious vineyard and winery Valley Green Landscape helps to maintain. The vineyard has its own grounds crew, but needs some extra manpower to help with all of the mowing, edging and spraying. The facility manager used to be one of Kory's employees so the partnership was a logical one. Two part-time employees, Paul Carden and Matthew Nettrouer, join Kory and Gary every Friday to spruce up the vineyard.



Kory Knutz is pretty proud of his mancave, which doubles as Valley Green Landscape's headquarters. Kory gets decommissioned Walker signage from his dealer to help decorate.

"We spend the entire day there running all four Walkers," Kory says. A 48-inch GHS handles the high-visibility areas around the winery. Three side-discharge mowers, two 62-inch and one 74-inch, handle the more open areas. Kory's sprayer attachment also comes in handy on the massive property.

As intensive as this huge account is, Kory says it is relatively straightforward and predictable, which is precisely why he loves landscape maintenance in the first place. Gone are the days of doing installation work when the majority of each day was spent responding to clients, creating bids, chasing materials and doing other administrative chores.

"Nowadays, with being completely focused on maintenance, I spend

about an hour a week with my bookkeeper and that's it," Kory says. Then he's right back in the seat of one of his four Walkers.

"One thing I like about maintenance is the routine," Kory says. "But I also like that you can never stop learning, whether it's a new plant or weed treatment or a more efficient way to mow. You can never stop learning. Once you stop wanting to learn, that's the day you'll start hating your job."

Kory Knutz admittedly started to hate his job back in 2008. Not anymore. Now he's maintaining properties that are Walker-friendly, and he's nearly stress-free in the process.

"Who would've thought that mowing lawns for over 30 years wouldn't leave me bored?" Kory ponders. "I don't know, maybe I'm just a really simple guy." Or maybe he has just found his sweet spot.



Kory Knutz has 10 decks for his four Walker tractors. He uses his Model H with 74-inch side-discharge deck for mowing spacious areas, including his own property as shown here.

See Kory's story by watching this video.



SCAN ME

Walker Decks: Mulching and Collection

Each Walker deck is uniquely configured to meet a very specific performance need. Whether the most important consideration in looking for the perfect deck is cutting width, handling grass clippings, material capacity, or grass type, there is a Walker deck that will meet the specific maintenance need.

Mulching Decks and Mulching Kits

Mulching decks and kits are designed to efficiently re-cut material to fine particles and return them to the turf, leaving a beautiful cut.

M36

- 36" (91 cm)
- Gear Drive
- Compatible with Models S, C19, C19i, T, D, and B

M42

- 42" (107 cm)
- Gear Drive
- Compatible with Models S, C, T, D, and B

M42B

- 42" (107 cm)
- Gear Drive
- Compatible with Models S, C, T, D, and B

S42-R Mulch Kit

- Mulch Kit for S42-R
- Compatible with Model R only

M48

- 48" (122 cm)
- Gear Drive
- Compatible with Models S, C, T, D, B, and H*

S48-R Mulch Kit

- Mulch Kit for S48-R
- Compatible with Model R only

M52

- 52" (132 cm)
- Gear Drive
- Compatible with Models T, D, B and H*

S52 Mulch Kit

- Mulch Kit for S52
- P/N 8691
- Compatible with Models C, T, D, B, and H*

S54-R Mulch Kit

- Mulch Kit for S54-R
- Compatible with Model R only

S61 Mulch Kit

- Mulch Kit for S61
- P/N 2692-1
- Compatible with Model H only

*Requires Deck Arm Adapter Kit P/N 2430-10.

Recirculating blade hubs

Unique housing designed to direct air flow



Serrated wing blades for fine mulching

See more details about mulching decks at:
www.walker.com/decks#mulching



See how GHS works



walker.com/grass-handling-system



Standard Rotation:
Good for thick, heavy
clippings and debris

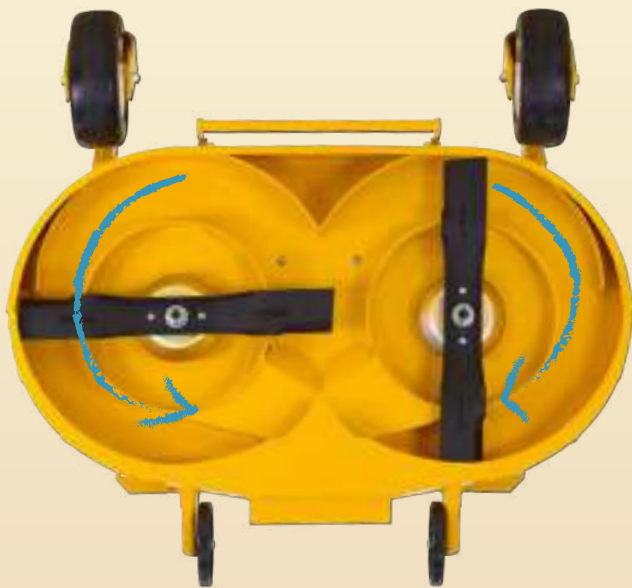

Reverse Rotation:
Exceptional cut quality when
clippings are light and dry

Collection Decks

Collection decks are compatible with the Walker Grass Handling System® (GHS) Models S, C, T, and D. Clippings are discharged from the deck through the internal blower and discharge chute, and stored in the GHS catcher box.

C36R

- 36" (91 cm)
- Reverse Rotation
- Compatible with Models S, C19, C19i, T, and D

C48

- 48" (122 cm)
- Standard Rotation
- Compatible with Models C, T, and D

C42

- 42" (107 cm)
- Standard Rotation
- Compatible with Models S, C, T, and D

C48R

- 48" (122 cm)
- Reverse Rotation
- Compatible with Models S18, C, T, and D

C42R

- 42" (107 cm)
- Reverse Rotation
- Compatible with Models S, C, T, and D

C52R

- 52" (132 cm)
- Reverse Rotation
- Compatible with Models C19i, T, and D

Standard vs Reverse Rotation

Standard rotation blades come together at the front of the deck, moving material directly into the rear discharge chute. Standard rotation decks are ideal for users who need to collect thick, heavy clippings, including leaves and other yard debris.

Reverse rotation blades come together at the rear of the deck, moving material around the edges of the deck before it is channeled into the discharge chute. Reverse rotation decks are ideal for users looking for exceptional cut quality, in mowing conditions without wet, heavy clippings or debris.

More about collection decks:

[www.walkermowers.co.nz/
models/collection-decks](http://www.walkermowers.co.nz/models/collection-decks)

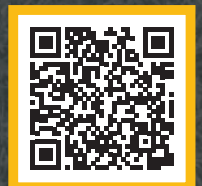

Walker Decks: Side and Rear Discharge

Side Discharge Decks

Compatible with all Walker Mowers, side discharge decks cleanly, and evenly, discharge cut grass from under the deck housing.

S36

- 36" (91 cm)
- Gear Drive
- Compatible with Models S, C19, C19i, T, D, and B

S42

- 42" (107 cm)
- Gear Drive
- Compatible with Models S, C, T, D, and B

S42-R

- 42" (107 cm)
- Belt Drive
- Compatible with Model R only

S48-R

- 48" (122 cm)
- Belt Drive
- Compatible with Model R only

S48

- 48" (122 cm)
- Gear Drive or Belt Drive
- Compatible with Models S18, C, T, D, B, and H*

S52

- 52" (132 cm)
- Belt Drive
- Compatible with Models C, T, D, B, and H*

S54-R

- 54" (137 cm)
- Belt Drive
- Compatible with Model R only

S56

- 56" (142 cm)
- Gear Drive
- Compatible with Models S18, C, T, D, B, and H*

S60

- 60" (153 cm)
- Belt Drive
- Compatible with Models C, T, D, and B

S61

- 61" (155 cm)
- Belt Drive
- Compatible with Model H only

S74

- 74" (188 cm)
- Gear Drive
- Compatible with Models T, D, B, and H*

Sizes range from 74"

to 36"



See more about all discharge decks at:
www.walkermowers.co.nz/models/discharge-mulch



*Requires Deck Arm Adapter Kit P/N 2430-10.

S48-2 Deck



Gear Drive:
Smooth, exceptional cut quality

S48-3 Deck



Belt Drive:
Flexible mowing, even
in rough conditions

Gear vs Belt Drive

Walker gear-driven decks utilize aluminum or cast iron gearboxes with bevel Zerol gear technology for durable and quiet function. The timed blades provide exceptional cut quality and striping, and allow a compact design for improved trimming and maneuverability.

Walker belt-driven decks use a robust spindle and belt-tensioning idler design, and are best suited for rougher mowing conditions with debris or ground contact occurring. Walker belt-driven decks feature tool-free belt change and easy-to-maintain spindles and components.

Rear Discharge Decks

Designed specifically for Model H mowers with high production and fast mowing speeds, Walker rear discharge decks process clippings numerous times before cleanly and evenly discharging clippings out the back of the deck, leaving an evenly cut turf.

R52

- 52" (132 cm)
- Belt Drive
- Compatible with Model H only

R64

- 64" (163 cm)
- Belt Drive
- Compatible with Model H only



H27i with 64" rear discharge deck

Walker Decks: Multi-Deck® and Add-ons

Multi-Deck®

The Walker Mower Multi-Deck® has the capability to collect, side-discharge or mulch the grass and, true to Walker reputation, it does each job beautifully.

How the Multi-Deck® works:

Simple and straightforward baffle system changes the cutting modes without tools. The baffles are secured with hand knobs to achieve the various configurations. The tilt-up allows quick and easy access to the underside of the deck. The changeover between cutting modes is done in less than a minute. When you invest in a Walker Mower you get long lasting quality, versatility and a machine that will always mow your lawn beautifully!

Learn more:

www.walkermowers.co.nz/models/multi-deck



Available Deck Add-ons*

- Dethatcher attachment
- Pneumatic Deck Tires
- Deck Height Adjuster
- Adjustable Footrests
- Spyker® Spreader and Mount
- Deck Cuff Kit
- Curb Jumper
- Power Tilt-Up® Deck Lift for S61, R52, R64 decks (Model H only)
- Accelerator® Grass Catcher Kit
- Boom Sprayer attachment
- Breakaway Blades

*Visit walker.com for deck add-on compatibility.

Learn more about the passion and philosophy behind the design of Walker decks:

walker.com/advantage/beautiful-cut/by-design



Collection



One deck,
multiple uses



Mulch



Side Discharge



Boom Sprayer



Breakaway Blades

Deck/Kit Compatibility

Decks/Kits	Models						
	S	C	T	D	R	B	H
Collection							
C36R	●	●	●	●			
C42/R	●	●	●	●			
C48		●	●	●			
C48R	●	●	●	●			
C52R		◆	●	●			
Discharge							
S36	●	●	●	●		●	
S42	●	●	●	●		●	
S42-R					●		
S48-R					●		
S48	●	●	●	●		●	▲
S52		●	●	●		●	▲
R52							●
S54-R					●		
S56	●	●	●	●		●	▲
S60		●	●	●		●	
S61							●
R64							●
S74			●	●		●	▲
Mulching							
M36	●	●	●	●		●	
M42	●	●	●	●		●	
M42B	●	●	●	●		●	
S42-R Kit					●		
S48-R Kit					●		
M48	●	●	●	●		●	▲
M52			●	●		●	▲
S52 Kit		●	●	●		●	▲
S54-R Kit					●		
S61 Kit							●
Multi-use							
Multi-Deck®	●	●	●	●			

Collection



Discharge



Mulching



Multi-Deck



● Compatible. ◆ Model C19i and C23i only.
▲ Requires Deck Arm Adapter Kit P/N 2430-10.



Eliseo Mauricio of Mauricio Lawn & Landscape Maintenance, mows the private home of one of his clients in Amarillo, Texas.

The Math Adds Up in Amarillo

Eliseo Mauricio, owner of Mauricio Lawn & Landscape Maintenance in Amarillo, Texas, learned the proper way to mow lawns at a young age. He helped out in his father's lawn maintenance business for a whopping \$40 a month. "As a kid, that seemed like a lot of money," Eliseo relates.

More importantly, Eliseo got to work with his dad. He was also able to discover how much he enjoyed working outside and making people happy by making their lawns look beautiful.

Eliseo had a second passion, though: math. Much like how he and his father "spread the joy" of having an enviable lawn, Eliseo wanted to spread the joy of math. "Well, at least as much as the average person can find math to be joyful," Eliseo says with a grin.

After mowing lawns with his father through high school, Eliseo decided to attend college. He continued mowing while earning his degree in mathematics. Upon graduation Eliseo became a high school math teacher, but he continued mowing a handful of lawns for a little extra money.

"I was a teacher for 10 years," Eliseo points out. "My side mowing business started with around five customers. Then it grew to 10. My intention was to keep it there, but then I decided to just let things go where they wanted to go. Right around the mark of 30 customers, I decided that I wanted to go ahead and take the plunge and do this full-time."

That was 2017. Today Mauricio has roughly 60 customers, primarily average-size residential lots he can service in 30 to 45 minutes. "I do have one commercial property," Eliseo adds.

"It's a warehouse. The only reason I do it is because the owner is one of my residential customers. I've tried getting into some commercial work, but my bid was always too high. But like I've told my wife, Adriana, I'd rather be too high and not get the job than be the lowest and not be able to do a good job."

Following the Pattern to Success

For his first several years in business, Eliseo worked alone and preferred it that way. Over the past couple of years, however, he has started to evolve his mindset.

"As I've been full-time in business for five years now, I've realized that I don't need to keep all of the money to myself," Eliseo says. "What good is having all of this money if you're too exhausted to do anything after work? Working so much was definitely starting to affect my health, and that was starting to affect my wife and three daughters."

As nice as it has been to have a seasonal helper these past couple of years, Eliseo stresses the fact that he will only hire someone he can count on to uphold the same standards he obsesses about. It is those high standards that have helped build a business without any advertising. Eliseo's truck and trailer have no branding. He doesn't even have business cards. Everything happens through word of mouth and from people seeing the work he does on neighboring lawns.

"I take a lot of pride in what I do and don't want to just mow," he says. "I think that is what has added to my customer base. My customers all expect and value quality, and are very kind and loyal. Proper weeding and edging play a part in that. But



one thing a lot of customers don't know much about are the patterns I put down on their lawns. I alternate four different patterns: parallel to the house, perpendicular to the house and two diagonals. Customers just love the way that looks, especially the ones who are big baseball fans. This machine (Walker Mower) is awesome at putting down those stripes."

To help keep things straight, every lawn gets the same pattern every week. When Eliseo gets on a property, it's not unusual for him to spend a few minutes looking for the stripes left behind from the last time he mowed that pattern. If the sun isn't

shining just right and he can't find them, he just starts over. Either way, the customer gets the gorgeous checkerboard pattern that prompted them to hire Eliseo in the first place.

Amarillo is a really hot, windy environment. Eliseo says the lawns he mows are all well-irrigated. They are also well-fertilized, often by Eliseo himself.

"A good 85% of my customers have me do both the mowing and fertilizing," Eliseo says. "Most of the products I use are granular. I have a spreader attachment for my Walker that I like to use, if possible. My Mondays and Fridays are usually a bit lighter. That's when I like to set up my Walker with the spreader. This past spring was unusually rainy, though, and I was often playing catch-up. So then I just put a walk-behind spreader in my trailer and do the applications that way. One thing I've learned in business is that you have to learn to adapt."

Adept at Adapting

Speaking of adapting, the scorching Amarillo climate can even be punishing for someone who grew up in Texas. Eliseo has become regimented about chugging a liter of water every time he arrives at a property. He has also taken a liking to his back-vented, long-sleeve polyester shirts with UV protection that keep him cooler and safer on the job while looking professional.

Eliseo is also learning to adapt to scorching gas prices. When asked what impact that has had on profitability this year, the mathematics maestro pulls out his smartphone, swipes the screen a couple of times and says, "It looks like fuel is running about 5.5% of sales so far. Not the end of the world."

One thing that has helped is the move to battery-powered handheld equipment. Eliseo even has a battery-powered 21-inch push mower for those few times his Walker Mower can't squeeze through an especially narrow gate.

"I invested in battery equipment two years ago," Eliseo tells. "We haven't had any problems. I have plenty of backup batteries on the trailer. The only time we had an issue was when I forgot to recharge the batteries overnight. Just to be safe, I do keep some gas-powered tools on the trailer as a backup. But we've had a lot of success with battery, aside from the debris blower. To really move a lot of debris, especially leaves, we stick with a gas-powered backpack blower for the extra power."

Going forward, Mauricio is hopeful that he won't forget to charge batteries overnight. In fact, he's hopeful that he won't even have to try and remember. He has recently invested in a kit to install solar charging panels on top of his enclosed trailer. This will allow him to recharge batteries right on the trailer at the jobsite, all while he is



Eliseo Mauricio,
owner of Mauricio
Lawn & Landscape
Maintenance in
Amarillo, Texas



Eliseo Mauricio bought his first Walker Mower in 2010 when he was just mowing part-time. He says his productivity gains were immediate, which gave him the confidence to start thinking about doing this full-time.

manicuring those four-pattern lawns with his Walker.

"My wife still thinks I work way too much," Eliseo says. "But really, I'm

into this business debt-free. We sold everything and have been living the RV life for a few years while we build our new house. We're 80% of the way there. We are just so blessed."

"Bagging always leaves a really good quality. But in the summer when things start slowing down a bit, I've started mulching. Customers really like the look that it is leaving. A lot of customers can't even tell the difference."

In Amarillo, that math of mowing lawns has definitely added up for this entrepreneur.

To be specific, Eliseo has more than one Walker. The first one he purchased was a Model C back in 2010 while mowing part-time. He bought his next machine, a Model T, a few years later to get a little more horsepower. Two years ago he bought a Model B and began adding mulching into his repertoire.

just blessed. My wife has supported every decision I've made. The only thing that held me back from going full-time sooner was the income. I was making pretty good money as a math teacher. We knew the income from mowing would eventually be there, just not right away. That's why it was so important that we go

"There are a lot of contractors with Walker Mowers in this area and most do a lot of bagging," he says. "Bagging always leaves a really good quality. But in the summer when things start slowing down a bit, I've started mulching. Customers really like the look that it is leaving. A lot of customers can't even tell the difference. That's a testament to the quality product Walker is putting out there. At the same time, I'm able to provide a good product, too, because I'm able to return some of those nutrients back into the lawn at a time when it is hottest and the lawn can get the most stressed."

"Stressed" is a word that owner/operators like Eliseo Mauricio can come to know all too well.

See Eliseo's story by watching this video.



SCAN ME



Eliseo Mauricio says many of his customers are baseball fans and value the checkerboard pattern he puts down on their lawns.

Add-ons: Implements

Implements mount interchangeably on most Walker models using the quick-change hitch system and require the use of the Implement Hitch. Tail Weights may also be needed for counterbalancing.

Implement Hitch

The Implement Hitch replaces the mower deck and installs on the tractor in just a few minutes. Implements then slide onto the hitch and lock in place with the flip of a lever for true "quick-change" capability. The Hitch assembly includes operator footrests and an electric power lift. A switch raises and lowers implements and is mounted on the Forward Speed Control lever for convenient operation.

- Models C, T, D:..... P/N H10
- Model H:..... P/N H19
- Model B:..... P/N H21

Option: Tail Weights

Tail weights are used for counterbalancing many Walker front-mounted add-ons such as a snowblower, loader bucket, or rotary broom. Tail weights also improve handling when using large decks on the lighter models. The cast-iron weights bolt directly to the chassis frame or the split-axle tail.

- Model B: 50 lb.....P/N 4647-10
- Extra 50 lb weightP/N 4647-11
- Model H: 50 lbP/N 2647-10
- Model H: 55 lb.....P/N 2647-11
- Extra 55 lb weightP/N 2647-6
- Model C19, C19i, T, D: 85 lb.....P/N 7647
- Extra 10 lb weight.....P/N 7647-5

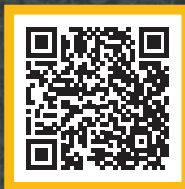

Learn more:
www.walkermowers.co.nz/models/attachments-accessories/



The Implement Hitch allows the Walker to use implements



Tail Weights offset the weight of an implement to maintain balance





Great for removing debris from textured surfaces



Five angle positions

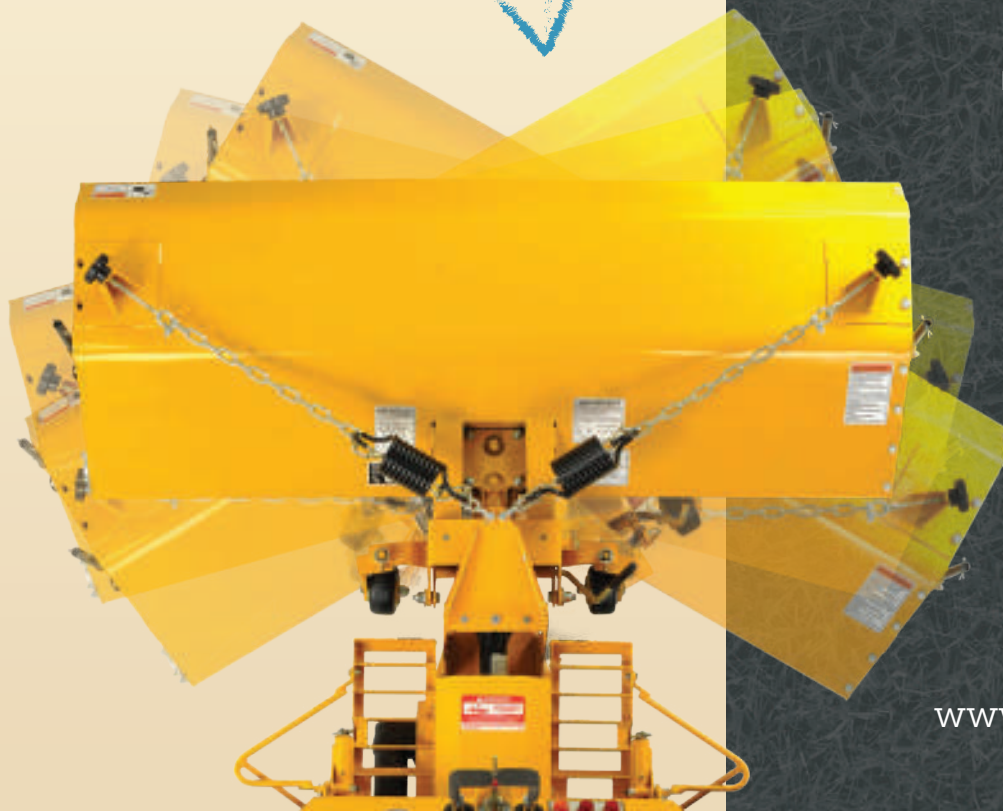

Rotary Broom

The Rotary Broom, with a 47" or 60" sweeping path and five-position angle head, is ideal for sweeping debris or light snow from hard surfaces.

The Rotary Broom excels at sweeping and removing gravel and debris from turf areas along roads, paths, and playing fields, and can also be used for lawn dethatching and raking. Down pressure is spring counter-weighted and is adjustable for great sweeping action and minimum brush wear. The Rotary Broom is another way to extend the usability of the Walker commercial riding lawn mower. Requires Implement Hitch (see page 44).

Models B, C, T, D: 47"P/N H13

Model H: 60"P/N H20

Optional Gauge Wheels:

Available to better control depth of brush engagement. Especially useful when working on turf. **P/N 1399**



Add-ons: Implements

Dozer Blade (48" or 60")

The Dozer Blade is a powerful tool able to tackle a variety of tasks, from cleaning up after a snow storm to backfilling irrigation trenches. It is designed and built by Walker, using the latest fabrication technology, precision tooling, and quality workmanship.

Blade design features a simple foot-actuated angle-adjust mechanism that allows the operator to quickly set the blade to five different positions. The design also employs trip-over protection with adjustable preload, and $\pm 5^\circ$ of lateral oscillation to follow ground contour for even cleaning over the full width of the blade, and integrated footrests. The steel cutting edge is replaceable, with four mounting positions for extended life.

Requires Implement Hitch (see page 44).

Models C, T, D, B, H: 48" (122 cm) P/N H11

Models T, D, H: 60" (152 cm) P/N H16

An optional Polyurethane Wear Edge Kit is available for use on sensitive surfaces:

48" (122 cm) P/N 6625-10

60" (152 cm) P/N 6625-11

Loader Bucket

A versatile tool for landscaping work, the Loader Bucket will push, scoop, haul, and grade dirt, stone, gravel, and mulch. It lifts approximately 180 lb (82kg), holds 2.25 cu. ft. (64 liter) of material, and features 14" (36 cm) ground clearance for transport. The Loader Bucket has a high-strength steel cutting edge with tilting action, powered by a 500 lb electric ram. It is available for use on models B, C, T, and D. It requires an Implement Hitch (see page 44). **P/N H18**



Replaceable wear edges





Debris Blower

Useful for landscape clean-up and leaf removal, the Debris Blower quickly mounts to the Implement Hitch and gives the Walker Mower owner full three-season use.

The 13.5" (35 cm) Debris Blower delivers 125 MPH velocity and a 230 degree manual directional control. The same high-quality construction found in each of our commercial mowers is built into this and each implement we offer. It is available for use on models B, C, T, and D. It requires an Implement Hitch (see page 44). **P/N H14**



Two-Stage Snowblower (42" or 50")

This powerful add-on throws snow up to 40 feet (12 meters) with a directional discharge spout that can be adjusted 228 degrees from the operator seat. The chute pitch-adjustment allows for fine control of throw angle and distance, and comes with an optional electric control kit. With the electric height-adjustment of the Implement Hitch, the Snowblower will make quick work of even the deepest of snowfalls. It requires an Implement Hitch (see page 44).

Models C, D, T, B, H: 42" (107 cm) P/N H12

Model H: 50" (127 cm) P/N H17

Optional Chute Control Kit:..... P/N 6623-4

Note: Required for use with Operator Hard Cab.



Throw snow up
to 40 feet

Add-ons: Attachments

Attachments mount interchangeably on most Walker models and do not require the use of an Implement Hitch. Some attachments replace the deck, while others attach to the deck or to the tractor body.

Hard Cab

The Hard Cab shields the operator from winter weather when using a Snowblower, Rotary Broom, or Dozer Blade. It includes two hinged doors, glass windshield with electric windshield wiper, LED headlights, and circulation fan. It requires a ROPS kit for mounting (see page 49). Compatible only with H models. **P/N A33**

Optional Operator Cab Heater

Use only with Model H37i:..... **P/N 2200-24**

Blade Angle Adjustment Kit

Use with 60" Dozer Blade:..... **P/N 6623-10**

Snowblower Chute Control Kit

Use with 50" Snowblower: **P/N 6623-4**

Soft Cab

The Soft Cab shields the operator from winter weather when using a Snowblower, Rotary Broom or Dozer Blade. It features a hinged door with glass windshield, electric windshield wiper, and LED Headlights. **P/N A17**

Models D, T Mounting Kit: **P/N 7660-23**

Model B Mounting Kit:..... **P/N 7660-24**

Model C Mounting Kit: **P/N 7660-25**

Front Cab Extension Flap

Protects operator when using Dozer Blade: **P/N 7661-4**



Protection from winter elements



Learn more:

www.walkermowers.co.nz/models/attachments-accessories

ROPS comes standard on Model H24d



ROPS

The Walker Roll-Over Protection Structure (ROPS) consists of a high-strength steel roll bar and retracting inertial-reel seat belt. The ROPS system features a hinged roll bar that can be folded down for convenient transport and storage.

Models H27i, H24d..... P/N A30
Model H37i, H38i..... P/N A34
Models C, D, T..... P/N A37*

**Seat belt ordered separately. Suspension Seat (6103-14) P/N 2302-8, Standard Seat (5103) P/N 5103-9, Comfort Seat (6104-31) P/N 6104-7.*

Blow snow without an implement hitch



Single-Stage Snowblower 36"

Just the right size for tackling sidewalks and driveways, the 36" (91 cm) Single-Stage Snowblower attachment mounts directly in place of the mower deck in just a few minutes. A simple, manual lifting mechanism and footrests are integrated with the Snowblower mount. No separate implement hitch is required. The Snowblower is compatible with models S, C, T, D, and B. The Snowblower is the perfect winter season add-on to give the Walker year-round versatility. It is a compact, powerful addition to the Walker Mower, throwing snow up to 20 feet. **P/N A11**



Spyker® Spreader Attachment

The Spyker® Spreader Attachment combines a Spyker® S80-12010 Pro-Series Spreader with the versatile Walker Mower. No tools are needed to secure the spreader to the carrier frame of the Walker 42", 48", or 52" gear-driven decks.

Spyker® Spreader and Mount..... P/N A39
Spyker® Spreader Mount only..... P/N A38

Add-ons: Attachments

Dethatcher

The Dethatcher on the front of the Walker Mower is the ideal setup to quickly dethatch and mow a property. When used with the Grass Handling System® on Models S, C, T, and D, lawn thatch and debris are lifted, vacuumed, and collected in one pass. The Dethatcher features front-gauge wheels which allow the dethatching tines to maintain consistent depth on uneven or articulating properties.

The Dethatcher quickly attaches to the front of most 42", 48", and 52" Walker gear-driven decks with integrated adjustable mounting saddles. A lift lever with foot trigger lowers and raises the Dethatcher for easy transport when driving between lawn areas. Gauge wheels are adjustable to set and tune tine depth. The foldable handle allows the Dethatcher to be stored vertically against a shop wall or tied down against a trailer sidewall. **P/N A10**

Optional Wall Mount:

Securely and compactly mount the Dethatcher off the floor in a space-saving manner on your shop or garage wall. **P/N 6606-11**



Lift and remove thatch quickly and easily



Tool-free installation



Boom Sprayer

A helpful attachment for property maintenance, the Boom Sprayer easily mounts to most 42", 48", 52", and 62" Walker decks, and offers a 96" (244 cm) spray pattern, allowing operators to apply fertilizer or weed control in an efficient manner. A spray gun with a 20-foot (6 meter) hose allows the operator to leave the mower and apply liquid material to all landscape features. The spray tip adjusts to offer varying output, from a mist to a 35-foot (11 meter) stream. The 25 gallon (95 liter) tank allows easy cleaning of the tank and spray system. **P/N A16**

Mounting on 52" and 62" decks requires two Rear Sprayer Supports **P/N B037**

48" Dozer Blade

Developed to provide a durable, simple, and productive attachment for the Walker, the Dozer Blade incorporates a manual lifting mechanism not requiring an implement hitch. The Dozer Blade features a foot-actuated, angle-adjust mechanism that allows the operator to quickly set the blade to five different angles. The blade employs trip-over protection with adjustable preload to allow operators to focus on productivity, and not on what is hiding under the snow or dirt. A replaceable steel wear edge comes standard, and an optional polyurethane wear edge is also available. **P/N A32**

Adapter kits are required for using the A32 Dozer Blade:

Models B, S **P/N 4300-16**
Models C, T, D **P/N 5628-10**

Options available for the A32 Dozer Blade:

Polyurethane Wear Edge Kit 48" P/N 6625-10
Blade Attachment Power Lift Kit P/N 6622-17

48" Model R Dozer Blade

Designed specifically for the Walker Model R, the A44 is ideal for removing snow from sidewalks, driveways, and other pedestrian areas. It also functions as a light utility tool for moving dirt, mulch, or other debris.

The A44 features: five-way foot-engaged angle adjustment, trip-over protection, +/-5° of lateral oscillation to follow ground contour for even cleaning over the full width of the blade, manual lift lever with foot trigger release, and integrated footrests. **P/N A44**

 **New for 2023!**



Replaceable Wear Edges



Add-ons: Options



Comfort Seat embroidery

Comfort Seat

The Comfort Seat, standard on Models T and B, is custom-designed with improved seat-bolstering and back profile for increased posture and support. The base cushion features Elastomeric Vibration Control which greatly increases comfort during operation. Matching armrests are available as an optional upgrade.

- Models T, D..... P/N 6104-8
- Models B, S, C..... P/N 6104-9
- Model R..... P/N 6104-10
- Optional Armrests..... P/N 6104-17

Suspension Seat

Made by Grammer, this full-spring Suspension Seat includes dampening and adjustments for back angle, lumbar support, and operator weight. Armrests are standard on the Suspension Seat. This seat is standard on Models D21d and H24d, and is required for a ROPS seat belt. P/N 6103-14

- Models B23, B27i Mounting Kit..... P/N 6103-51
- Model C Mounting Kit..... P/N 6103-52
- Model H Mounting Kit..... P/N 6103-53
- Model T Mounting Kit..... P/N 6103-54

Armrests

Foldable Armrests can be added to the Comfort or Standard Seat. They offer enhanced operator comfort and security. Armrests conveniently fold up when not in use. Armrests are standard equipment on the Suspension Seat.

- Standard Seat:..... P/N 5885
- Comfort Seat:..... P/N 6104-17



Suspension Seat absorbs bumps as the mower goes over rough terrain

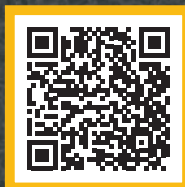
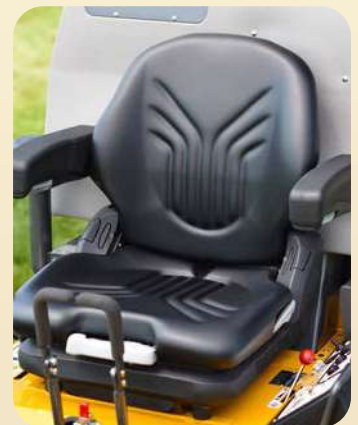

Learn more:

www.walkermowers.co.nz/models/attachments-accessories/



Increased safety
for early morning
and evening work



Utility Bed

The Utility Bed can replace the rear body assembly on the Model B, providing convenient storage and transport of material or tools. With manual dump functionality, the Utility Bed also adds all-season versatility to the Model B or H24d. It is standard on Models H24d and the non-collection versions of T23, T27i, and D21d. **P/N 4650-2**

Headlights

The LED Headlights incorporate a durable, cast aluminum housing with four LED lamps in each light assembly. The lights are positioned to illuminate the front and sides of the mower deck, providing increased situational awareness and safety for both the operator and bystanders.

Models C, H27i, H24d	P/N 5989-13
Model B	P/N 5989-17
Model S	P/N 5989-14
Model R	P/N 5989-15
Models D, T	P/N 7989-14
Model H37i, H38i	P/N 2989-12

Cup Holder

Featuring a unique front-mount design, the Cup Holder gives the operator easy access to his or her drink. The Cup Holder frame is powder-coated metal and incorporates rubber tabs to secure different sized and shaped cups and tumblers up to 3.25" in diameter. It is not Model R compatible. **P/N 5744-9**

Instrument Panel Cover

This sturdy canvas Instrument Panel Cover protects the instrument panel on Walker Models D and T when parked outside or trailered in rain or snow. **P/N 7307-2**

Add-ons: Options

Power Dump

The Walker Power Dump provides convenience and time-saving to commercial mowing companies and homeowners alike by giving the operator the ability to dump the grass catcher from the operator seat. A toggle switch operates the 12-volt electric linear actuator that provides the dumping and door-opening action, which completes in about 10 seconds.

- Model S18.....P/N 7620-18
- Model C19, C19i.....P/N 7620-14
- Models T, D.....P/N 8620-2

Hi-Dump®

The Walker Hi-Dump® raises up 67" (170 cm) and dumps collected grass and debris into a truck or trailer in a 20-second cycle without the operator ever needing to leave the seat. Powered by a 12-volt electric/hydraulic system, the lifting and dumping functions work independently and are controlled by two toggle switches near the operator's seat. It is available for Models D and T. **P/N A21**



Dump grass without leaving your seat



Lifts up 67"



Turn collection into rear discharge



Prevent clogging in wet conditions

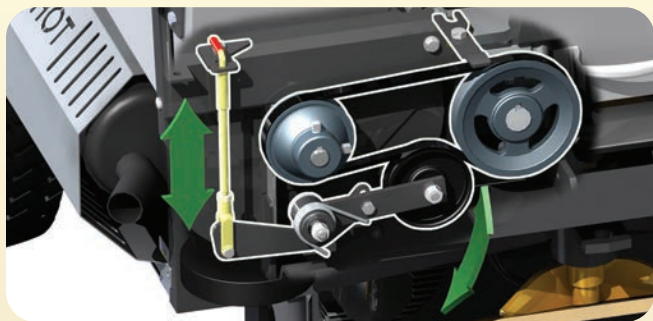

Transfer power when not using GHS



No-Catch Deflector

The No-Catch Deflector easily installs in the grass catcher door frame to allow "non-collection" rear-discharge mowing with GHS models. Grass clippings are safely deflected downward and spread across the door opening.

7.0 bu. Catcher..... P/N 7500-2
10.0 bu. Catcher P/N 8500-2

Large Hole Screen

When mowing in wet conditions, this screen with 3/4" holes stays cleaner to help prevent clogging. This screen easily interchanges with the standard screen.

7.0 bu. Catcher.....P/N 7512-13
10.0 bu. CatcherP/N 7512-11

GHS Blower Lockout

The Blower Lockout disengages the Grass Handling System® (GHS) blower to reduce noise and increase power when using a side discharge deck, mulching deck, or PTO-driven attachment or implement. Disengaging the blower also prevents grass, snow, or debris from entering the grass catcher. **P/N 7541-1**

Dump Bins

These two bins slide into the Walker 10-bushel catcher, making the dumping of grass clippings much easier by dividing the weight. This is especially useful for single operators working by themselves.

Set of Dump Bins.....P/N 8510-11
Left Side Dump BinP/N 8510-9
Right Side Dump Bin.....P/N 8510-10

Dump Bag

The reusable, fabric Dump Bag helps make on-the-job cleanup a lot easier. It is sized to fit the grass catcher door opening, allowing the operator to cleanly handle clippings and easily transport them.

10.0 bu. CatcherP/N 5598-2

Add-ons: Options

Deck Height Adjuster

The mechanical Deck Height Adjuster installs directly onto the Walker mowing deck. It offers quick and easy cutting height adjustments in 1/4" increments, using a single hand lever within reach of the operator's seat.

C36R, S36, M36	P/N A22
C42, S42, M42	P/N A23
C48, S48, M42B, M48	P/N A24
C48R, C52R	P/N A25
S52*	P/N A26
S62**	P/N A27
S56	P/N A28
C42R	P/N A29

*A26 S/N 163318 and prior S52 decks.

**A27 S/N 187999 and prior S62 decks.

Deck Height Washers

Deck Height Washers allow finer adjustments of cutting height on compatible decks. Use these to adjust deck height by 1/4".

36", 42", 48", 52", 54", 56" gear or belt drive decks	P/N 5727-1
52", 62" belt drive, 74" gear drive decks	P/N 8727

Curb Jumper

This 40" (102 cm) wide curb ramp allows Walker Mowers to easily back over a standard curb for access to medians, landscape areas in parking lots, and raised beds. When not in use, the ramp stows on the mowing deck carrier frame and functions as an expanded footrest.

Standard Decks	P/N 5597
Deck Height Adjuster Decks	P/N 5597-1



Fine-tune cutting height



Store as a footrest



Easy to use ramp



Power Tilt-Up®

Available for the Model H, the Power Tilt-Up® makes it easy to automatically tilt up decks for maintenance, transportation and storage. Tilt-up action uses a 12-volt electric linear-actuator easily mounted to any Model H mower equipped with an S61, R52, or R64 deck with adjustable footrests. The use of a tailweight is suggested (see page 44).

Models H27i, H37i P/N A35
Model H24d..... P/N A36

Deck Lift

The Deck Lift raises the front casters of the deck a few inches off the ground to avoid wear and tear on the deck while transporting. The Deck Lift mounts directly to a Walker tractor and deck. Compatible only when Standard Seat is installed.

Model B.....P/N 4645

Avoid heavy lifting; mechanically lift decks

Lift deck to transport over rough areas

Breakaway Blades

Use Breakaway Blades in mowing conditions with frequent ground contact and/or excessive debris. Breakaway Blades lessen the impact and shock loading on the deck drivetrain and reduce blade damage. Cutting blades can be easily replaced or removed for sharpening.

S56..... P/N 5705-32
S42..... P/N 5705-33
S74..... P/N 5705-34
S48..... P/N 7705-8

Reduce damage when mowing debris

Add-ons: Options

Deck Cuff

Airflow and deck contour tend to push grass at the very edges of the deck away from the cutting blades. The Deck Cuff acts as a channel to direct grass at the edge of the deck into the blade cutting path, restoring full deck cutting width.

- C36R..... P/N 7704-2
- C48R..... P/N 7704-4
- C52R..... P/N 7704-5

Spread Axle Tail Wheel

The Spread Axle Tail Wheels track in line with the drive tires for grass conditions where the center tail wheel track may not be preferred. This offers a clean look to the striping, improves straight tracking, and also contributes to stability when operating on hillsides.

- Spread Axle Assembly..... P/N 7420-3
- Tank Relocation Kit Required for D21..... P/N 7420-8



Wider wheel base = better hillside stability

Dual Tail Wheel

The Dual Tail Wheel comes standard on Models T and D. Featuring two independent pneumatic tires, it offers less turning resistance than the Single Wide Tail Wheel, offering mowing with greater agility and precision. P/N 7420-20



Direct grass into cutting path



Less turning resistance with greater agility



Creates a single, uniform tire stripe

Better comfort for operators of all heights

Single Wide Tail Wheel

The Single Wide Tail Wheel creates a single, uniform tire stripe in the middle of the cutting width for a clean-looking stripe-pattern. It is not recommended for delicate turf, D Models, or machines equipped with a Hi-Dump® due to the increased turning friction at the contact patch of the tail wheel. **P/N 8049**



Adjustable Footrests

These Adjustable Footrests clamp onto the carrier frame. They are easy to install and adjust, making for a comfortable ride for operators with shorter legs.

36", 42", 48", 52"P/N 8662-10
74"P/N 8662-9

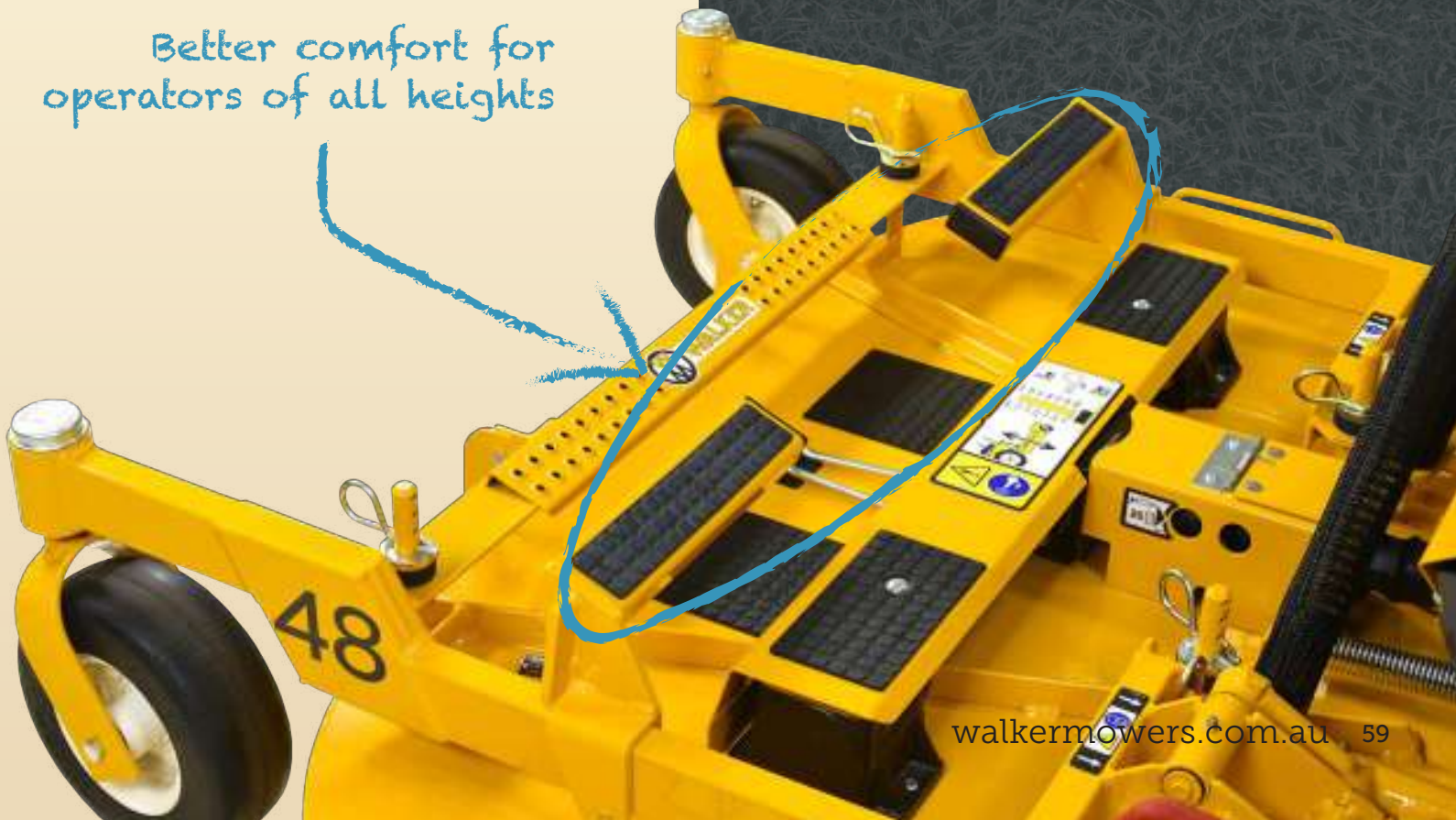

Add-ons: Options

Tail Wheel Lock

The Tail Wheel Lock uses a locking solenoid and detent to hold the tail wheel into a "straight ahead" position. This dramatically improves the ability to create straight stripes and stability for hillside mowing. An On/Off toggle switch located on the Forward Speed Control makes it easy to control from the operator seat. **P/N 8540**

Big Tire Fork Kit

This kit, available for the Model B only, uses a larger, 20" drive tire along with taller tail wheel and deck caster forks. It provides increased cutting heights up to 5", higher ground speed, and improved operator comfort in rough conditions.

For use with 8" Deck Tires P/N 5076-12

For use with 11" Deck Tires P/N 5076-13

Note: 20" Drive Tires are purchased separately, using P/N 5076 Turf Tire or P/N 8070-20 AT Tire.



Lock tail wheel in "straight ahead" position to help create straight stripes

For faster, more comfortable operation



Taller Deck Caster Forks

Larger, 20" Drive Tires

Taller Tail Wheel Fork

Use on narrow decks



Preferred for delicate turf and hills

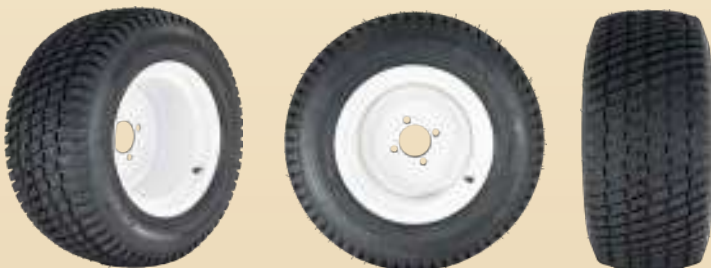
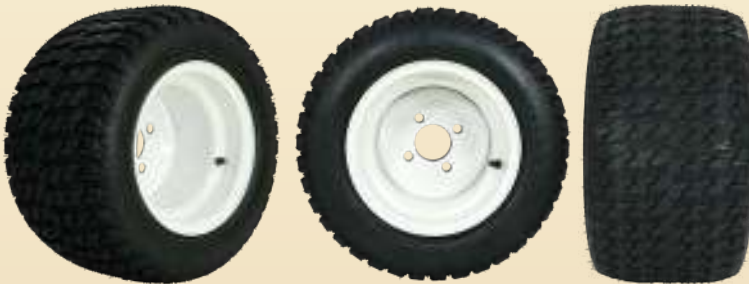

Turf Tires

18 x 7-8 Turf Tire

The 18 x 7-8 Turf Tire is ideal for use with narrow decks, attachments, or implements. With these tires, the overall width of the tractor stays within the cut width of Walker's 36" decks. Compatible with Models S, C, T, D, R, and B. **P/N 5033-6**

18 x 8.5-10 Turf Tire

The 18 x 8.5-10 Turf Tire features a low profile sidewall for increased stability on slopes and less sidewall flex in turns. The 18 x 8.5-10 Turf Tire keeps overall tractor width less than 42", ideal for narrower decks, attachments, or implements. This tire is standard on Models B, C, S18, and Models T and D with ROPS.

Compatible with Models S, C, T, D, R, and B. **P/N 5075-3**

Standard on Models B, C, S and T & D with ROPS

18 x 9.5-8 Turf Tire

The 18 x 9.5-8 Turf Tire is a good balance of low ground pressure, operator comfort, and deck overhang for trimming ability. It is the standard tire on Model T and Model D Walker Mowers without ROPS. Compatible with Models S, C, T, D, R, and B.

P/N 7070-2

Standard on Models T and D without ROPS

18 x 10.5-10 Turf Tire

The 18 x 10.5-10 Turf Tire provides optimum traction and a large contact area, reducing ground pressure and protecting the turf. The low profile sidewall improves hillside handling. Due to its width, and for optimal trimming, it should be paired with 48" or larger decks. Compatible with Models C, T, D, and B.

P/N 8075-4

22 x 10.5-12 Turf Tire

The 22 x 10.5-12 Turf Tire provides optimum traction while minimizing turf damage in normal mowing conditions for the Model H. This tire is standard on the Model H. Compatible with Model H. **P/N 2071**

Standard on Model H

Add-ons: Options

All Terrain Tires

18 x 7-8 Directional AT Tire

The 18 x 7-8 AT Tire features a high-traction, directional tread. It is ideal for increased traction in a variety of situations such as snow removal, dirt work, and mowing where a narrow, aggressive tire is needed. It is perfectly paired with the 36" Single-Stage Snowblower, the 48" Dozer Blade, or 36" and 42" decks. Compatible with Models S, C, T, D, R, and B.

Left Drive Tire: P/N 5034-1

Right Drive Tire: P/N 5034-2

18 x 8.5-10 AT Tire

These aggressive 18 x 8.5-10 high-traction tires feature increased traction useful for snow removal, dirt work, and other challenging mowing conditions. The tire width maximizes deck overhang for improved trimming capability, as well as dozer blade overhang to increase blade side reach. Compatible with Models S, C, T, D, R, and B. **P/N 8070-9**

18 x 11-10 AT Tire

The 18 x 11-10 All Terrain Tire is ideal for increased traction in a variety of situations ranging from hillside mowing to snow removal. It also features a low profile sidewall for increased stability and performance. Compatible with Models C, T, D, and B. **P/N 8070-12**

23 x 10.5-12 AT Tire

The 23 x 10.5-12 All-Trail Tire features a moderately aggressive, bi-directional tread pattern ideal for challenging turf applications. The All-Trail Tire improves traction and hillside performance for the Model H. Compatible with Model H. **P/N 2071-4**

Pair with 36" snowblower,
48" dozer blade, or
36-42" decks



Improved trimming
capability, and dozer
blade side reach

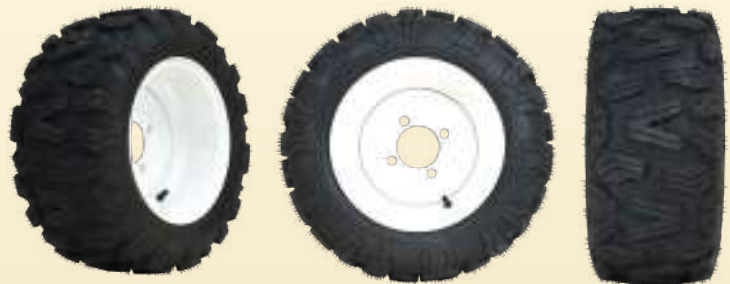

Increased traction and
performance on hillsides



Ideal for snow, dirt,
and challenging
mowing conditions



Standard tires on
most Walker decks



Can adjust air pressure



23 x 10.5-12 Directional AT Tire

The 23 x 10.5-12 Directional All-Terrain Tire provides improved traction for the Model H and is ideal for snow, dirt, and challenging mowing and implement conditions. The Directional AT tread layout is open enough to shed snow and mud, yet the tire rolls smoothly and performs well on manicured turf. Compatible with Model H.

*Left Tire: P/N 2070-5
Right Tire: P/N 2070-6*

Deck Tires

Semi-Pneumatic Deck Tire

Never again experience the downtime of having a flat deck tire. The Semi-Pneumatic Deck Tires are molded, structural rubber with a hollow core, and come standard on most Walker Decks. Compatible with Models S, C, T, D, and B.

*Tire, wheel and axle assembly: P/N 5715-23
Tire only: P/N 5715-16*

Pneumatic Deck Tire

For operators who like the ability to fine-tune the performance and ride of their Walker Deck, we offer a pneumatic tire option. The Pneumatic Deck Tires replace the standard semi-pneumatic tires and allow for adjustment of air pressure. Compatible with Models S, C, T, D, and B.

*Tire and inner tube only: P/N 5715-15
Tire, inner tube, and wheel assembly: P/N 5715-24*

Tire Chains

The Tire Chains are used for extra traction while working in snow with a Walker Snowblower, Rotary Broom, or Dozer Blade. There are tire chains to fit every Walker model.

- 18 x 6.5-8..... P/N 5675*
- 18 x 8.5-8..... P/N 5675-2*
- 18 x 9.5-8..... P/N 5675-3*
- 22x10.5-12..... P/N 5675-6*

Add-ons: Compatibility

	Models						
	S	C	T	D	R	B	H
Implements							
Implement Hitch ¹		▲	●	●		●	●
47" Rotary Broom		▲	●	●			
60" Rotary Broom							●
48" Dozer Blade		▲	●	●		●	●
60" Dozer Blade			●	●			●
Loader Bucket		▲	●	●		●	
Debris Blower		▲	●	●		●	
42" Two-Stage Snowblower		▲	●	●		●	
50" Two-Stage Snowblower							●
Attachments							
Operator Soft Cab		▲	●	●		●	
Operator Hard Cab							●
ROPS		▲	●	●			●
36" Single-Stage Snowblower		▲	●	●			
Dethatcher ²	●	●	●	●		●	
Boom Sprayer ²	●	●	●	●		●	●
48" Dozer Blade	●	▲	●	●		●	
Spyker® Spreader and Mount	●	●	●	●		●	
Options							
Comfort Seat	●	●	●	●	●	●	
Suspension Seat		●	●	●		●	●
Armrests	●	●	●	●	●	●	●
Utility Bed			●	●		●	
Headlights	●	●	●	●	●	●	●
Cup Holder	●	●	●	●		●	●
Instrument Panel Cover			●	●			
Tail Weights		●	●	●		●	●
Power Dump	●	▲	●	●			

● Compatible. ▲ Compatible with Models C19, and C19i only, not C23i.

¹ Required for use of compatible implements. ² Visit walker.com for a full list of compatible decks.

Models

	S	C	T	D	R	B	H
Options (continued)							
Hi-Dump®			•	•			
Large Hole Screen	•	•	•	•			
No-Catch Deflector	•	•	•	•			
GHS Blower Lockout		•	•	•			
Dump Bag	•	•	•	•			
Dump Bins			•	•			
Deck Height Adjuster ²	•	•	•	•		•	•
Deck Height Washers ²	•	•	•	•		•	•
Curb Jumper ²	•	•	•	•		•	•
Power Tilt-Up®							•
Deck Lift						•	
Breakaway Blades ²	•	•	•	•		•	
Adjustable Footrests ²	•	•	•	•		•	•
Deck Cuff ²	•	•	•	•			
Spread Axle Tail Wheel		•	•	•			
Dual Tail Wheel			•	•			
Single Wide Tail Wheel			•	•			
Tail Wheel Lock			•	•			
18 x 7-8 Turf Tire	•	•	•	•	•	•	
18 x 8.5-10 Turf Tire	•	•	•	•	•	•	
18 x 9.5-8 Turf Tire	•	•	•	•	•	•	
18 x 10.5-10 Turf Tire		•	•	•		•	
22 x 10.5-12 Turf Tire							•
18 x 7-8 Directional AT Tire	•	•	•	•	•	•	
18 x 8.5-10 AT Tire	•	•	•	•	•	•	
18 x 11-10 AT Tire		•	•	•		•	
23 x 10.5-12 AT Tire							•
23 x 10.5-12 Directional AT Tire							•
Semi-Pneumatic Deck Tire ²	•	•	•	•		•	
Pneumatic Deck Tire ²	•	•	•	•		•	
Tire Chains ³	•	•	•	•	•	•	•

• Compatible. ² Visit walker.com for a full list of compatible decks. ³ Visit walker.com for a full list of compatible tires.

Walker Mower Specifications

	S18	C19	C19i	C23i	T23	T27i	D21d	R21	B23	B27i	H24d	H27i	H37i	H38i
Engine	B&S Vanguard	Kohler CH620	Kohler ECH630	Kohler ECH630	Kohler CH680	Kohler ECH749	Kubota D722	Kohler KT620	Kohler CH680	Kohler ECH749	Kohler KDWM003	Kohler ECH749	B&S Vanguard	Kohler ECH980
Fuel System	Carb	Carb	EFI	EFI	Carb	EFI	Diesel	Carb	Carb	EFI	Diesel	EFI	EFI	EFI
Cooling System	Air	Air	Air	Air	Air	Air	Liquid	Air	Air	Air	Liquid	Air	Air	Air
Displacement (cc)	570	674	694	694	674	747	719	660	674	747	1028	747	993	999
HP @ 3600 RPM	18	19	19	23	22.5	26.5	20.9	21	22.5	26.5	23.7	26.5	37	38
Max Torque (ft-lbs)	29.2	35	34.2	34.2	36.8	40	34	35.9	36.8	40	36.8	40	53	53
Fuel Capacity US gal (liter)	4 (15.1)	4 (15.1)	4 (15.1)	4 (15.1)	4.7 (17.8)	4.7 (17.8)	4.7 (17.8)	3 (11.4)	4.7 gal (17.8)	4.7 (17.8)	9.4 (35.6)	9.4 (35.6)	9.4 (35.6)	9.4 (35.6)
Drive Tire Size (diameter x width)	18x8.5	18x8.5	18x8.5	18x8.5	18x9.5	18x9.5	18x9.5	18x8.5	18x8.5	18x8.5	22x10.5	22x10.5	22x10.5	22 x 10.5
Top Speed (MPH & km/h)	7.4 (12)	6.5 (10.5)	6.5 (10.5)	8 (13)	6.5 (10.5)	6.5 (10.5)	6.5 (10.5)	7 (11.3)	8 (13)	8 (13)	10 (16)	10 (16)	10 (16)	10 (16)
Tractor + Deck ¹ Length inch (cm)	89.25 (226.69)	89.25 (226.69)	89.25 (226.69)	93 (236.22)	93 (236.22)	93 (236.22)	93 (236.22)	93 ¹ (236.22)	90.75 (230)	90.75 (230.50)	107 (271.78)	107 (271.78)	108 (274.32)	108 (274.32)
Tractor + Deck ¹ Tilted Length inch (cm)	77 (195.58)	77 (195.58)	77 (195.58)	77 (195.58)	77 (195.58)	77 (195.58)	77 (195.58)	77 (195.58)	72 (183)	72 (182.88)	87.75 (222.88)	87.75 (222.88)	87.75 (222.88)	87.75 (222.88)
Height inch (cm)	46.5 (118.11)	47.5 (120.65)	47.5 (120.65)	50 (127)	50 (127)	50 (127)	50 (127)	42 (106.68)	39.5 (100)	39.5 (100.33)	50.5 ² (128.27)	46.5 (118.11)	46.5 (118.11)	46.5 (118.11)
Tractor Only Width inch (cm)	36.25 (92.07)	37.75 (95.88)	37.75 (95.88)	41 (104.14)	39 (99.06)	39 (99.06)	39 (99.06)	39 (99.06)	38.5 (98)	38.5 (97.79)	46.5 (118.11)	46.5 (118.11)	46.5 (118.11)	46.5 (118.11)
Tractor Only Weight lb (kg)	636 (289)	734 (333)	739 (335)	761 (345)	790 (358)	787 (357)	959 (435)	404 (183)	610 (277)	610 (277)	997 (452)	748 (340)	778 (353)	802 (364)
Tractor + Deck ² Weight lb (kg)	827 (390)	925 (420)	930 (422)	981 (445)	1009 (458)	1006 (457)	1178 (534)	575 (260)	848 (385)	848 (385)	1434 (650)	1185 (537)	1215 (551)	1239 (562)

¹S, C19, and C19i: C42, C23i, T and D: C48, R: S48, B: M48, H: R64, ²S: C36, C: C42, T and D: C48, R: 42¹ B: S48, H: R64, ³ROPS folded. Note: The A21 Hi-Dump Kit weighs 175 lbs (79 kg).

Standard Features

- Gasoline engines require unleaded 87+ octane
- Diesel engines require 2-D
- Full pressure lube systems with filter
- Heavy-duty stamped steel cutting blades, tempered
- Flywheel alternator charging, D21d has belt-driven alternator

- Internal mechanical parking brake
- Safety circuitry provided by safety switches: Seat, transmission neutral, blade clutch, and parking brake
- Electric blade clutch with easy pull/push switch operation on Models R, B, and C23i
- Dual-lever steering, precision friction-lock Forward Speed Control lever with neutral/park position

- All machines feature dual, independent hydrostatic transmissions
- Cutting height 1.5" to 4", 1.5" to 4.5", or 1" to 5", varies per model
- Welded, heavy gauge, steel chassis
- Decks and add-ons powered by splined PTO shaft with dual u-joints allowing dynamic articulation, except for the Model R

- Deck carrier frame with flexible deck suspension, caster wheels, and counterweight springs
- Welded, 14 gauge steel bodies
- Welded, 11 gauge steel decks
- 12V electrical systems
- Blade clutch and brake with manual belt tightener S, C, T, D, H

